

option1: corten steel structure



option1: corten steel structure



option 2: steel with colored finish





option 2: steel with colored finish



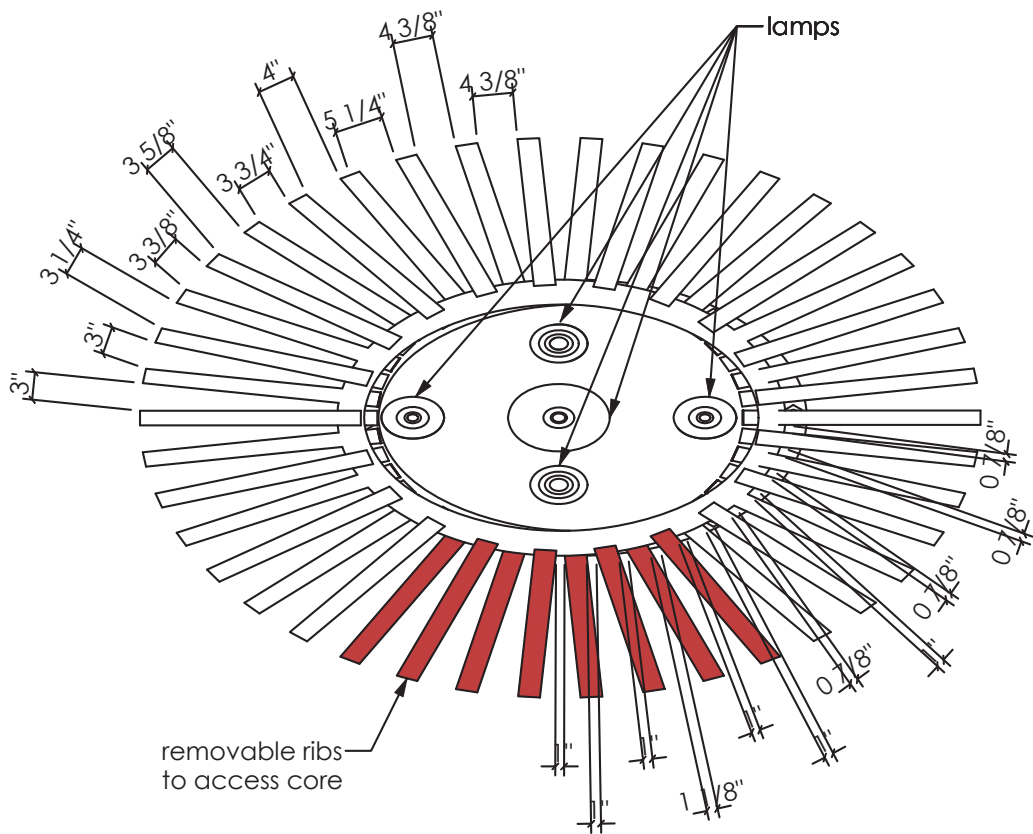



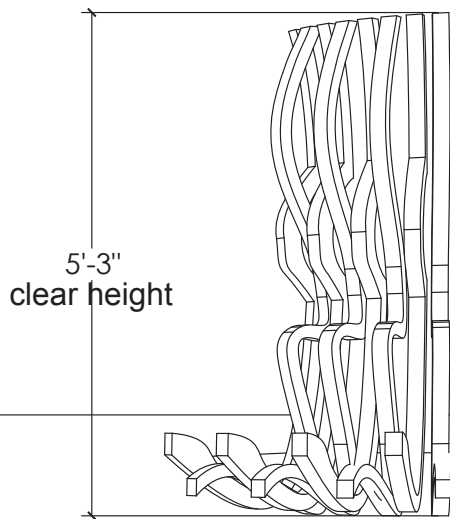
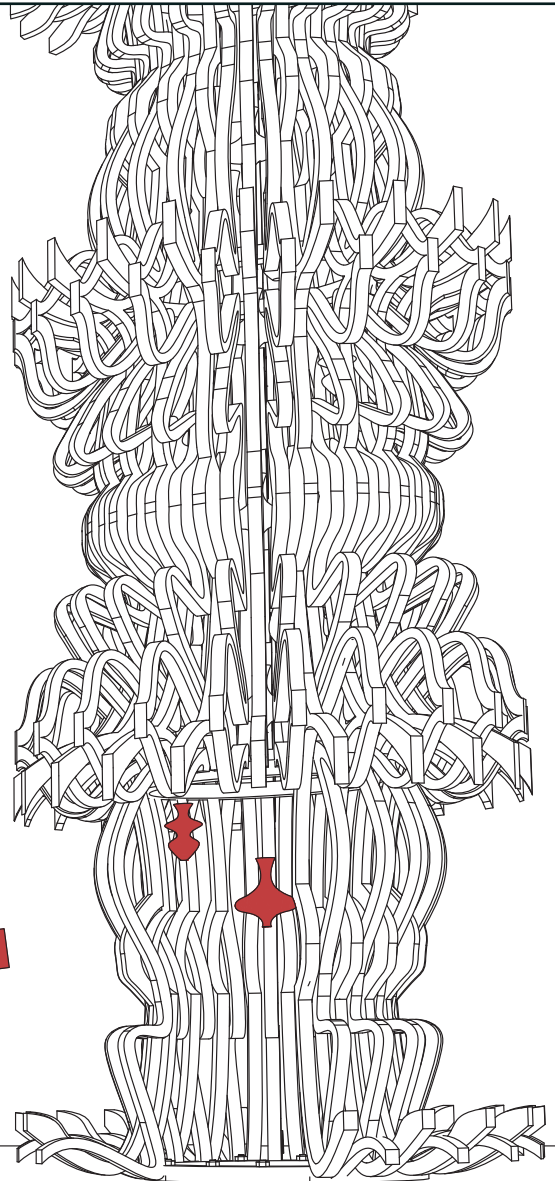

5'-3"  
clear height

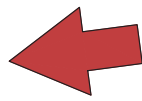

removable ribs to access core  
detail to be specified by structural engineer

1' 10-3/4"  
clear width





5 VAN NESS

THE UNIVERSITY OF CALIFORNIA

THE UNIVERSITY OF CALIFORNIA



# Jorge Pardo

Inspiration from portfolio



































# Van Ness Avenue



# Sculptures Location

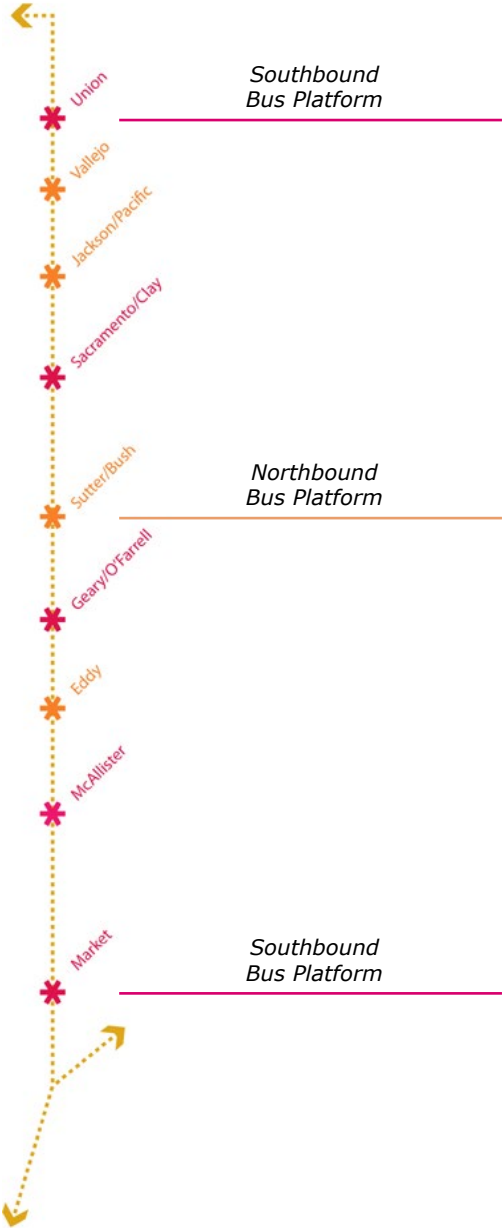

# Street Plan



Bus Platform  
Bus Lane  
Landscape



Bus Platform  
Bus Lane  
Landscape





# Sculptures Position

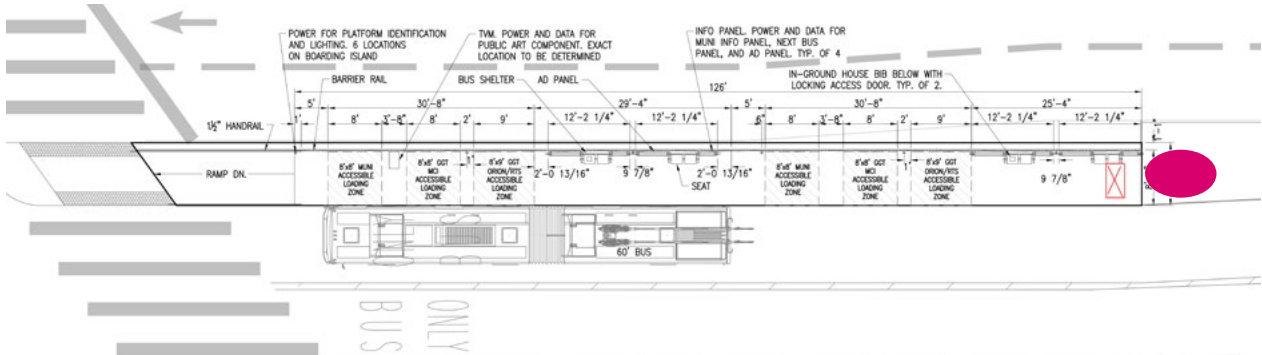

Market St. Southbound Platform

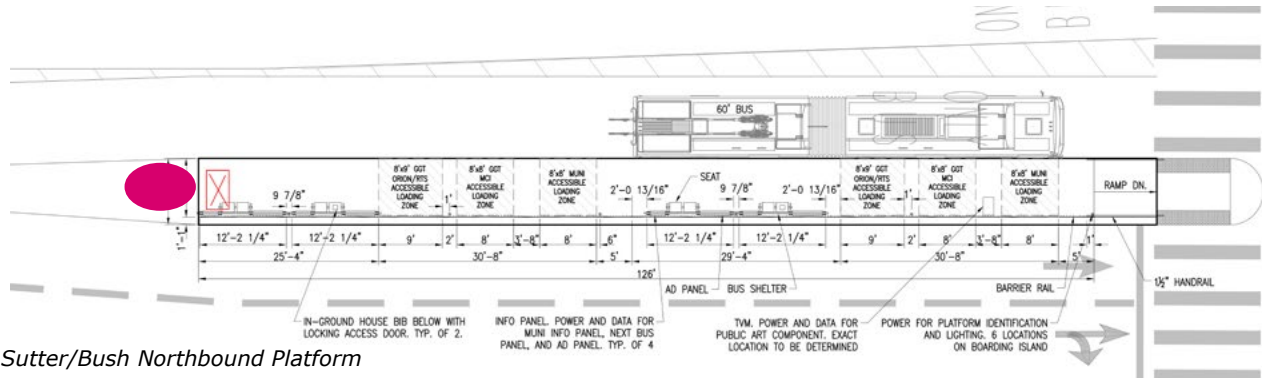

Sutter/Bush Northbound Platform

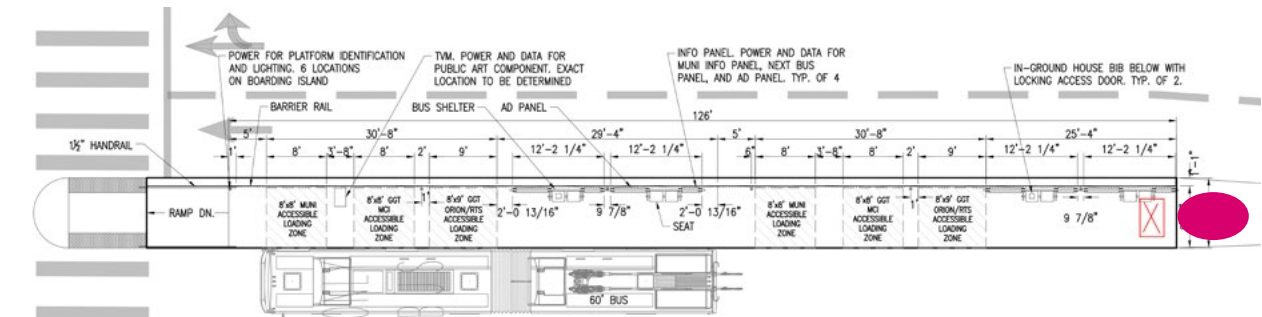

Union Southbound Platform



# JPS

Jorge Pardo Sculpture

Tina Pezeshkpour  
*tina@jorgepardosculpture.com*

Till von Rötzel  
*till@jorgepardosculpture.com*

Gabriele Iavazzo  
*gabriele@jorgepardosculpture.com*



# Jorge Pardo [*Penelope* - 2002]

Liverpool, UK

