

Castro Mission Health Center Seismic Upgrade

Civic Design Review Phase 1

June 19th 2017







Project Goals

- 1 Protect Human Life
- 2 Maintain Continuous Operation
- 3 Preserve Fenestration & Entry Plaza

Project Information

3850 17th Street
San Francisco, CA 94114

Existing Building Completed 1964
Two Story
15,258 sq ft
Concrete frame with CMU infill

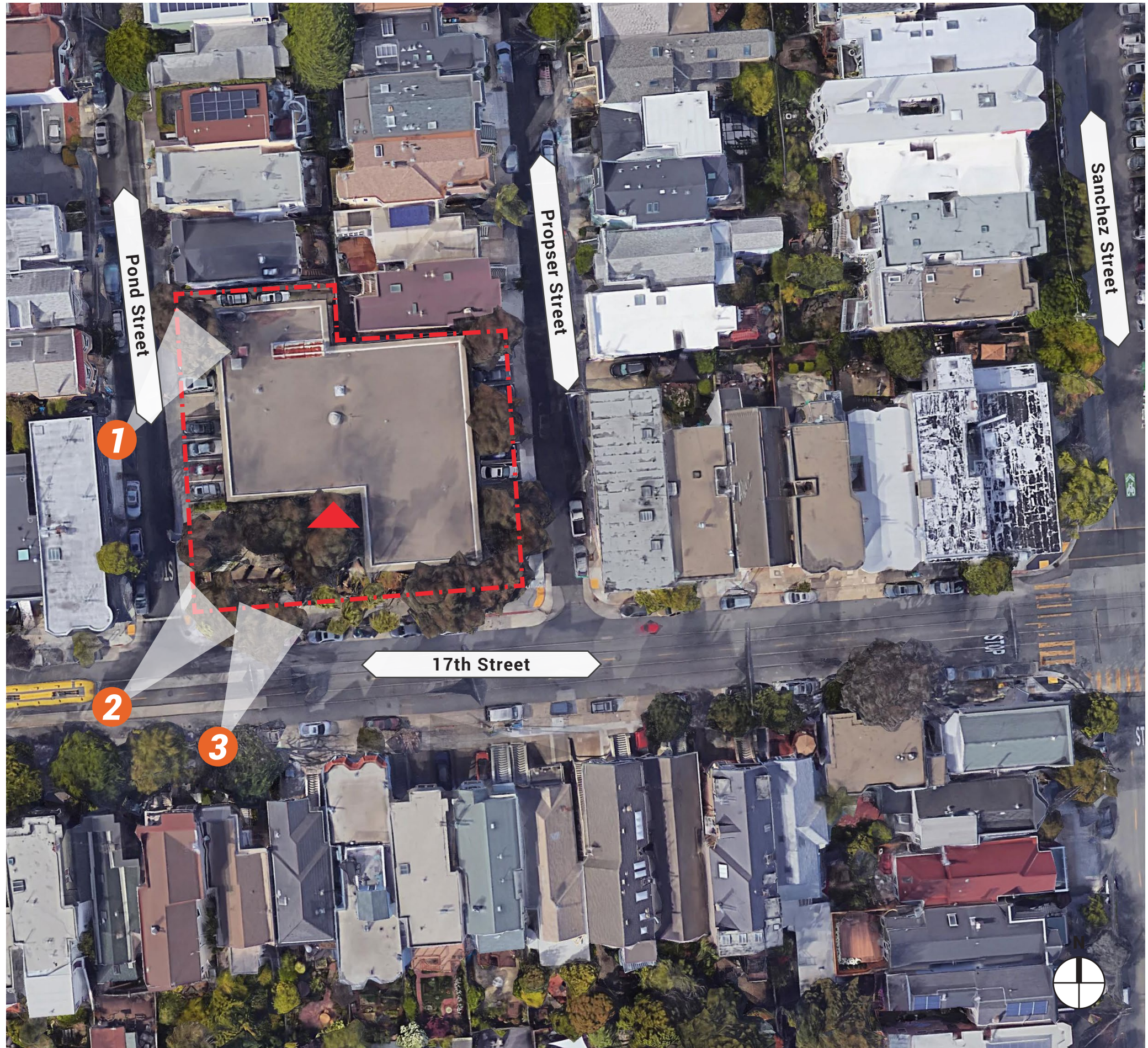
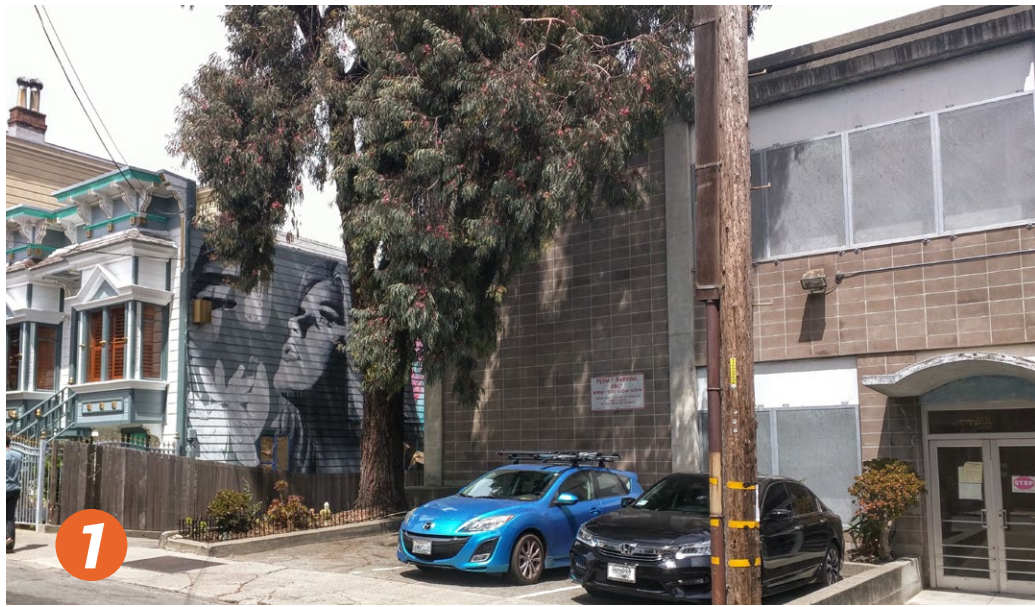

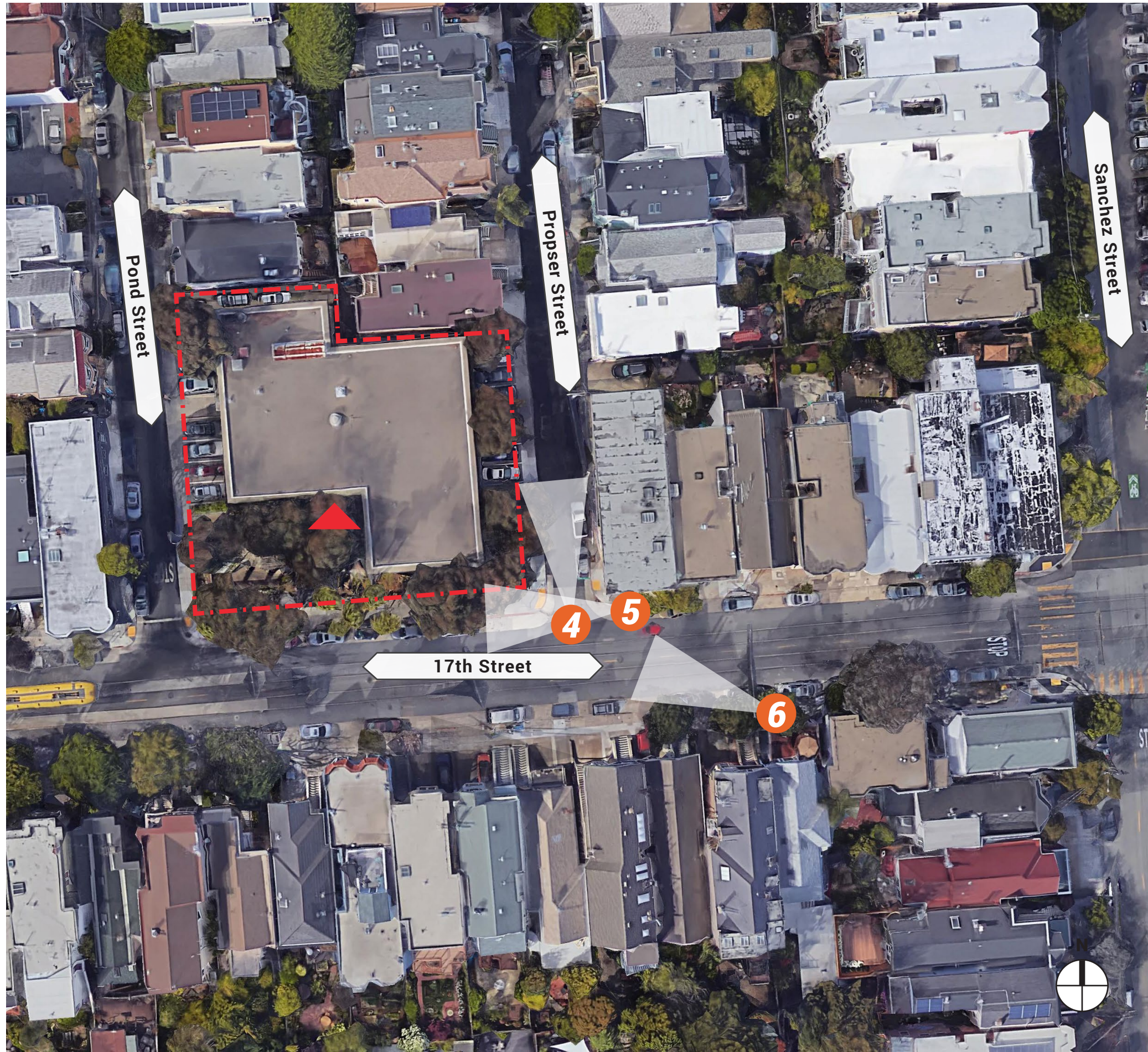
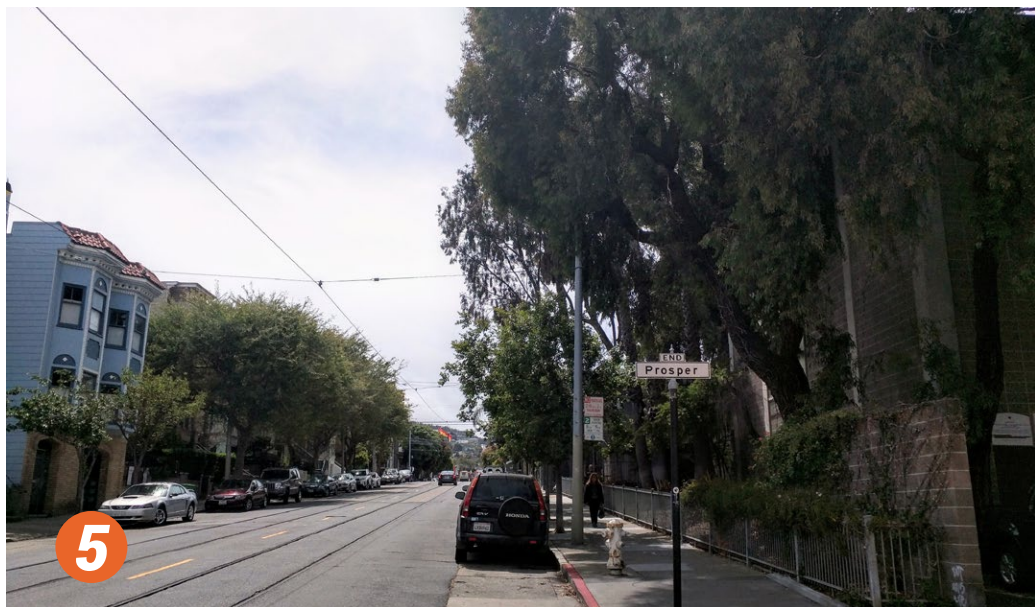

Hatch indicates walls potentially extended beyond minimum structural requirement to enhance final appearance

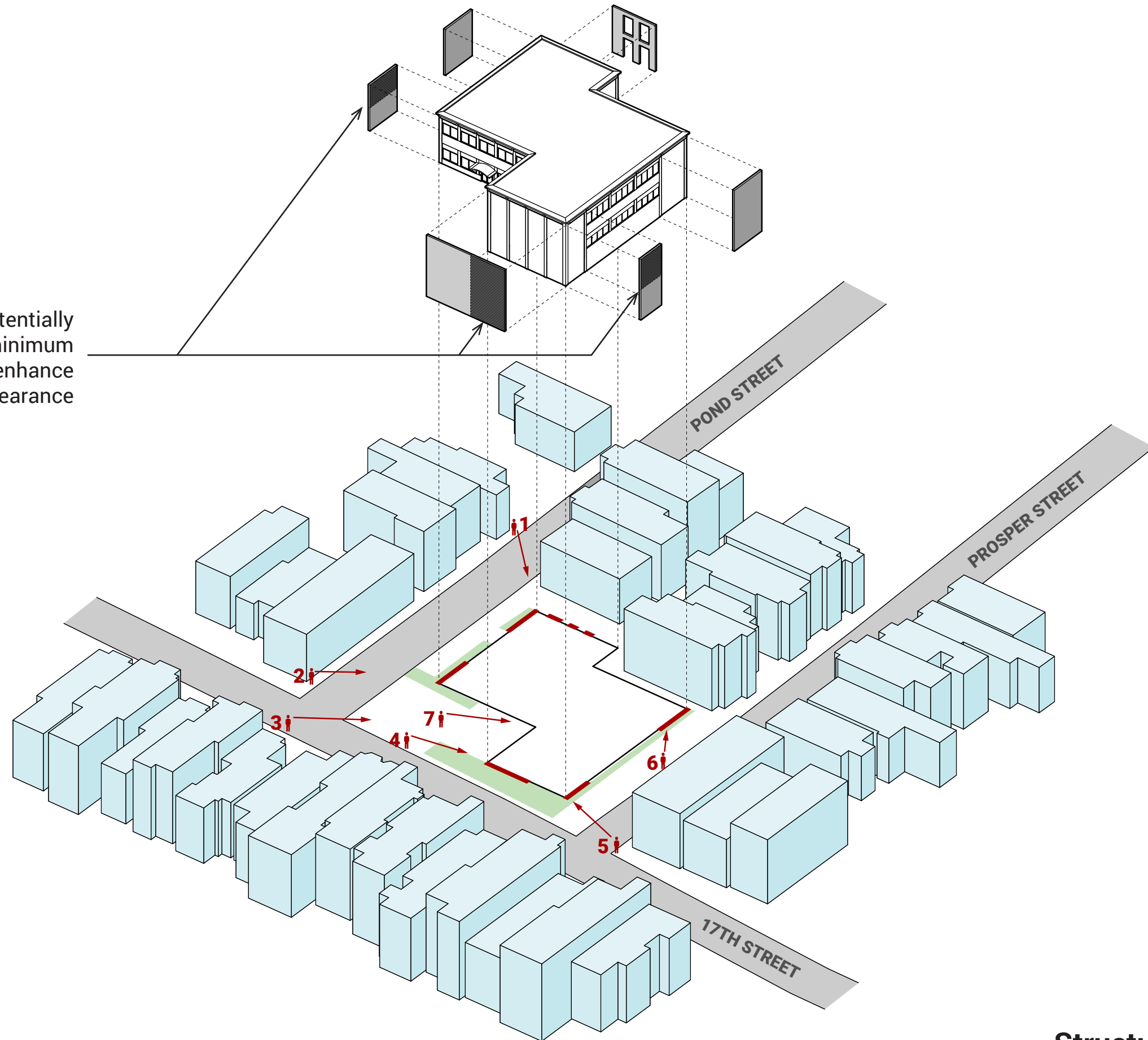

Structural Upgrade Overview

5'-10" FIGURE FOR SCALE

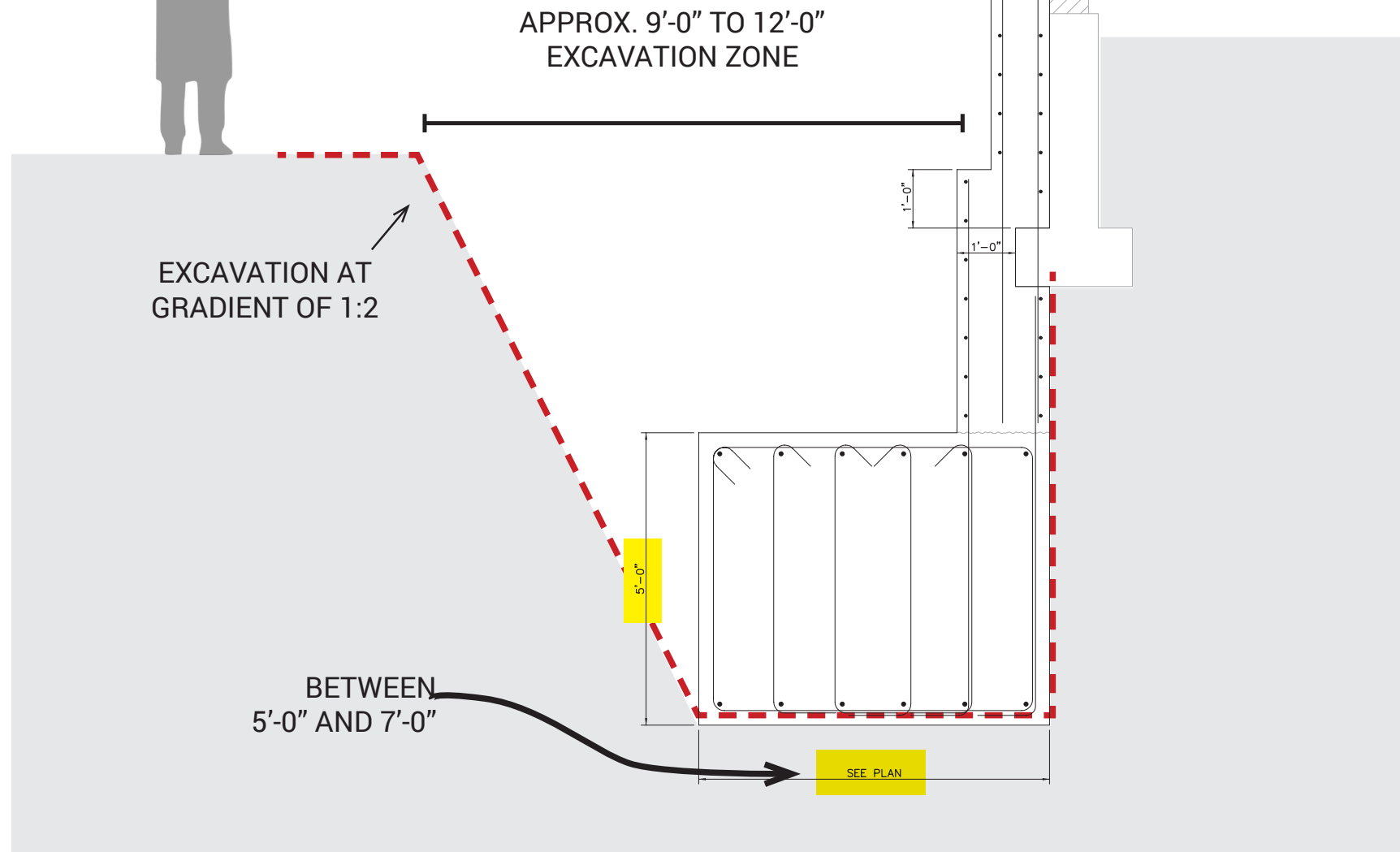

Structural Upgrade Typical Detail



Existing Conditions



Extent of Proposed Shotcrete Addition

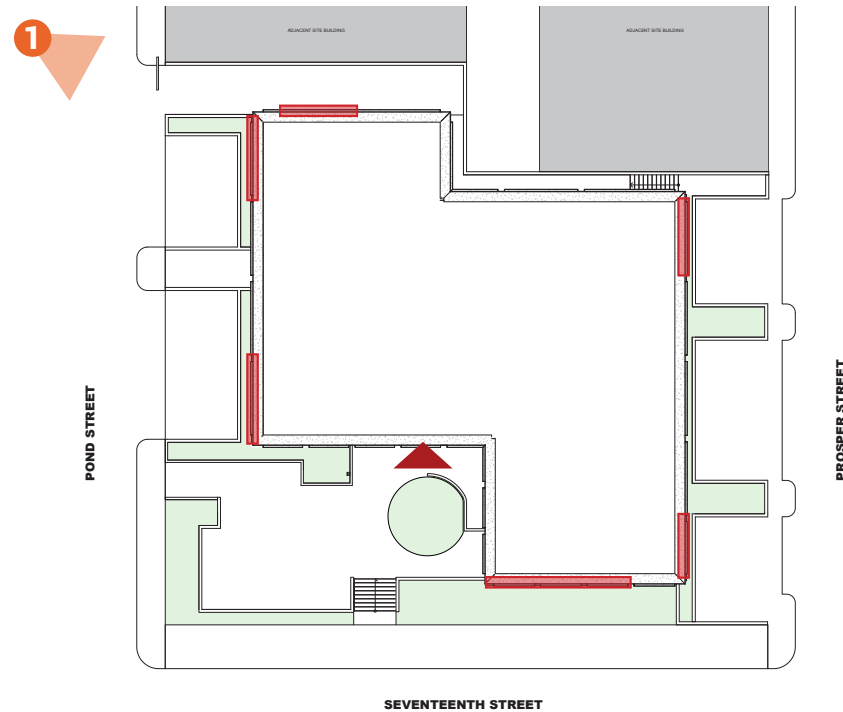

Site Plan

Visual Impact of Structural Upgrade



Existing Conditions



Extent of Proposed Shotcrete Addition

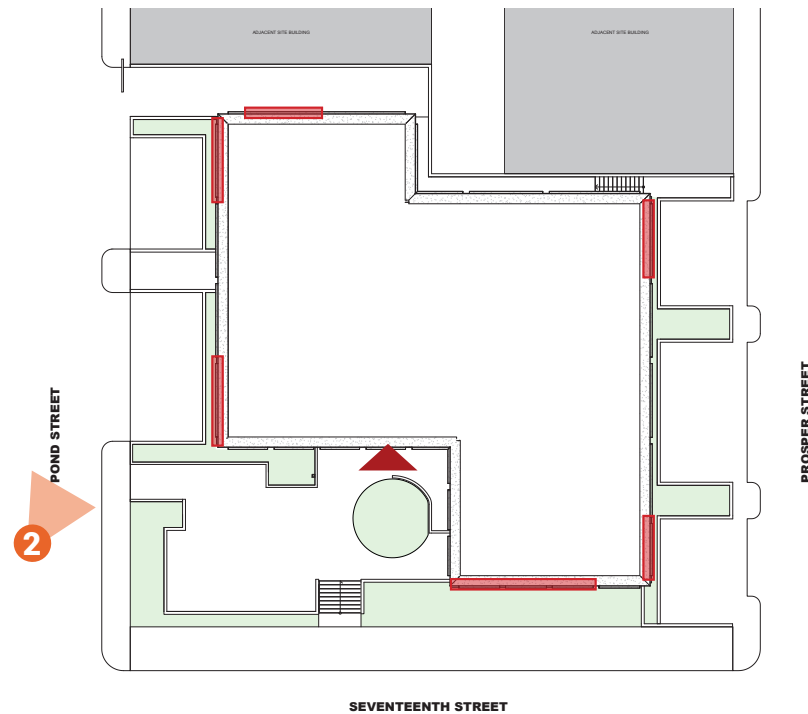

Site Plan

Visual Impact of Structural Upgrade



Existing Conditions



Extent of Proposed Shotcrete Addition

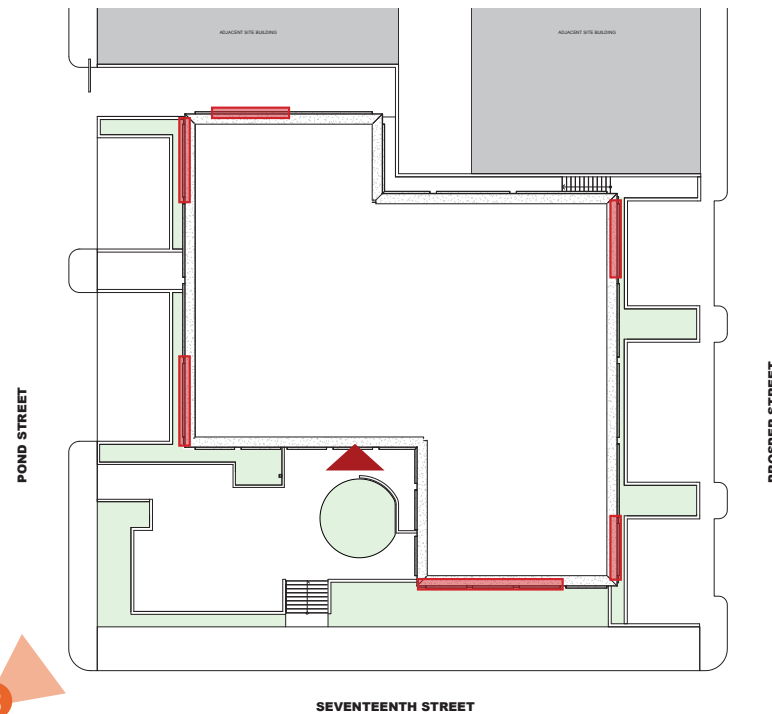

3 Site Plan

Visual Impact of Structural Upgrade



Existing Conditions



Extent of Proposed Shotcrete Addition

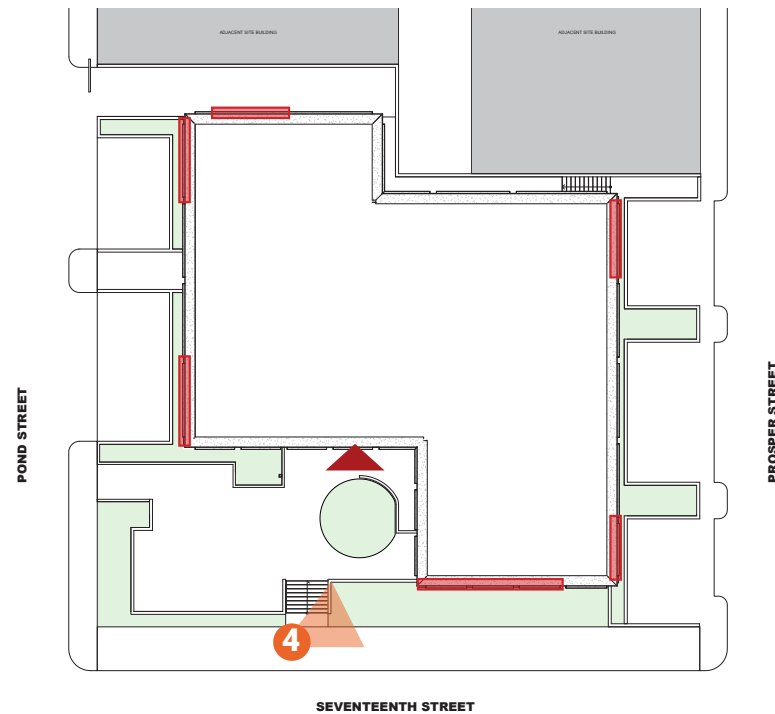

Site Plan

Visual Impact of Structural Upgrade



Existing Conditions



Extent of Proposed Shotcrete Addition

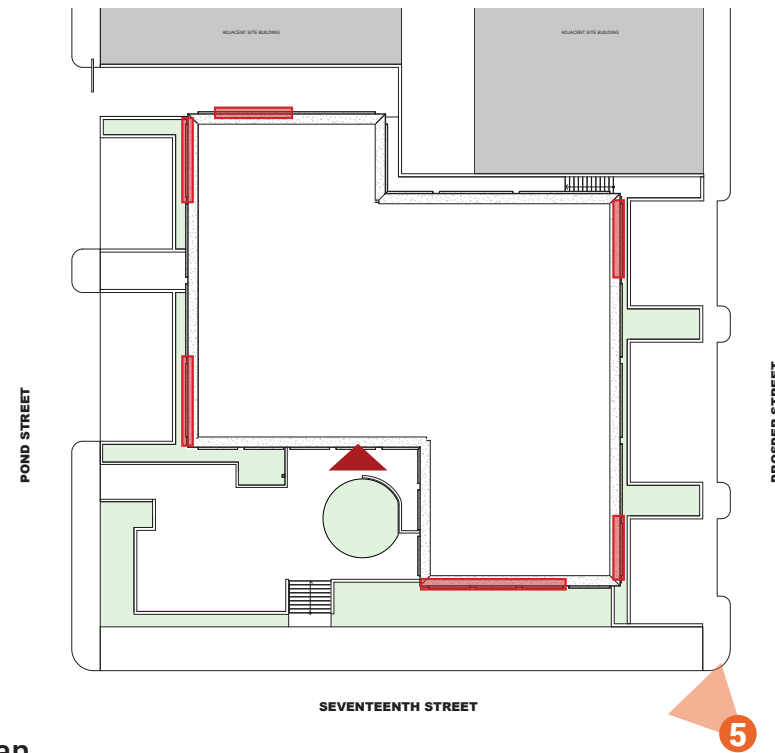

Site Plan

Visual Impact of Structural Upgrade



Existing Conditions



Extent of Proposed Shotcrete Addition

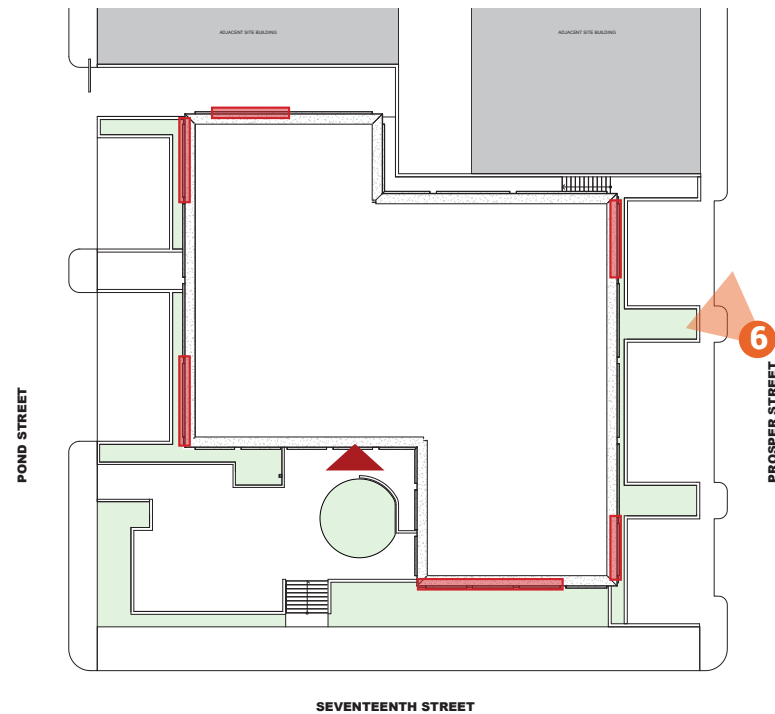

Site Plan

Visual Impact of Structural Upgrade



Existing Conditions



Extent of Proposed Shotcrete Addition

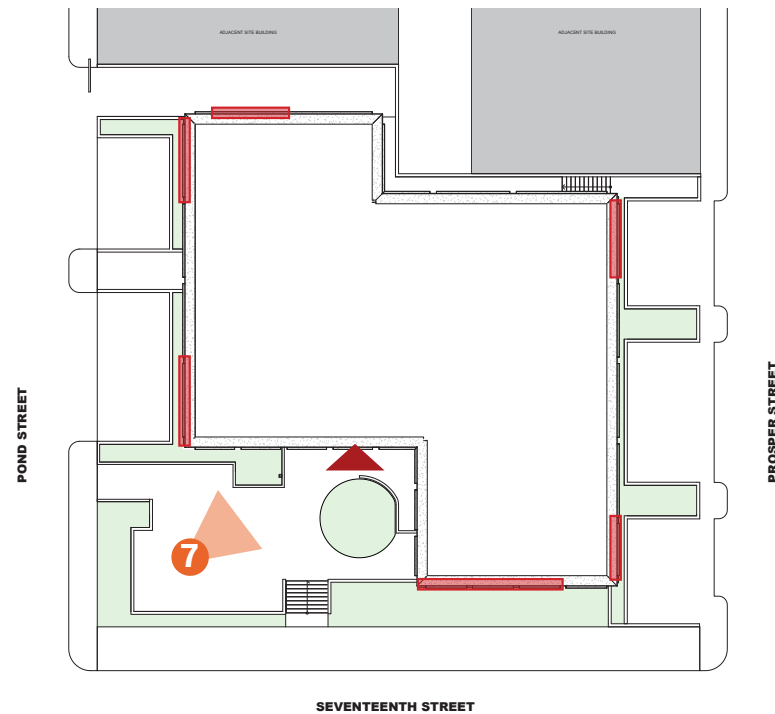

Site Plan

Visual Impact of Structural Upgrade

Facade Enhancement Options

Facade Enhancement Options

1

**Trowel Finish
Shotcrete**

2

**Cement Plaster
Finish with
Integral Color**

3

**Thinset
Ceramic Tile**

4

**Cast In Place
with Reveals**

5

**Cast in Place
with Relief**

OPTION 1 - Trowel Finish Shotcrete



Representative Finish

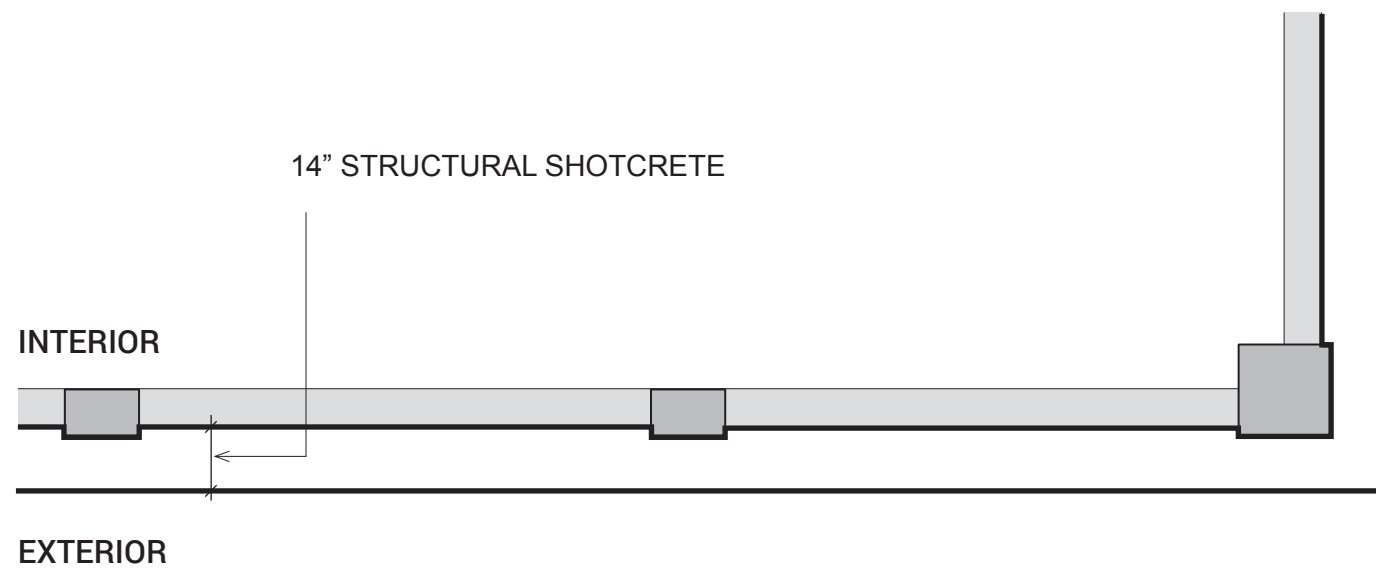

OPTION 2A - Cement Plaster, Integral Color, 3 Bay



OPTION 2B - Cement Plaster, Integral Color, 4 Bay

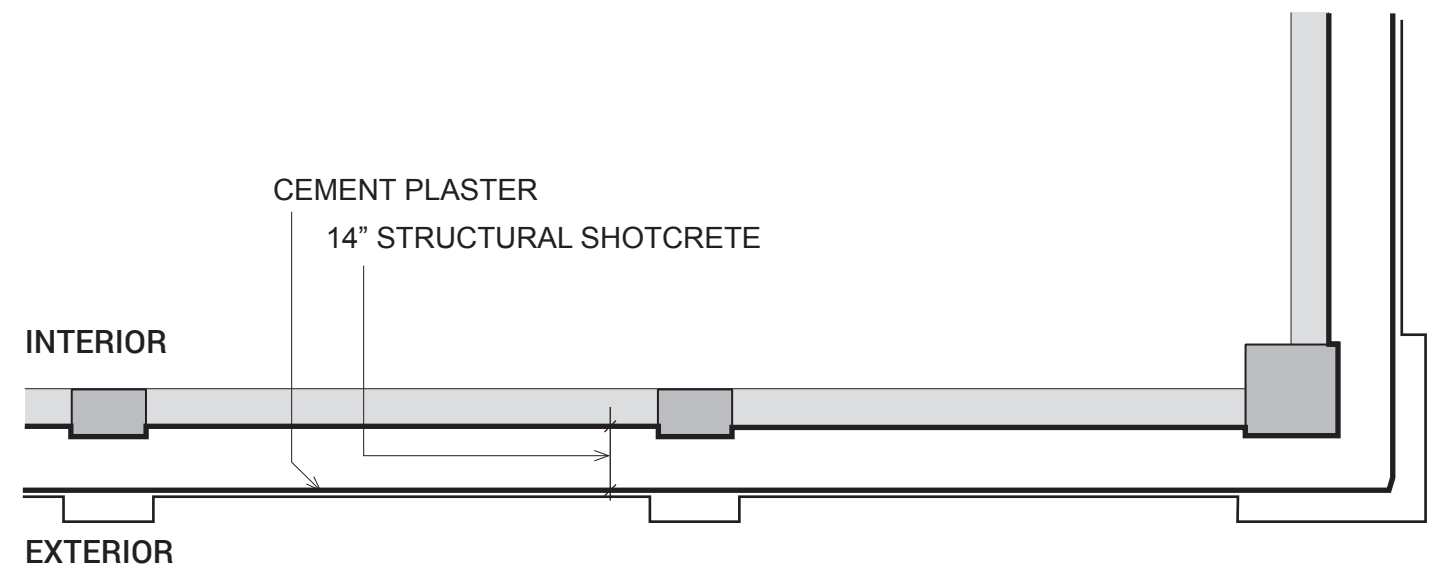
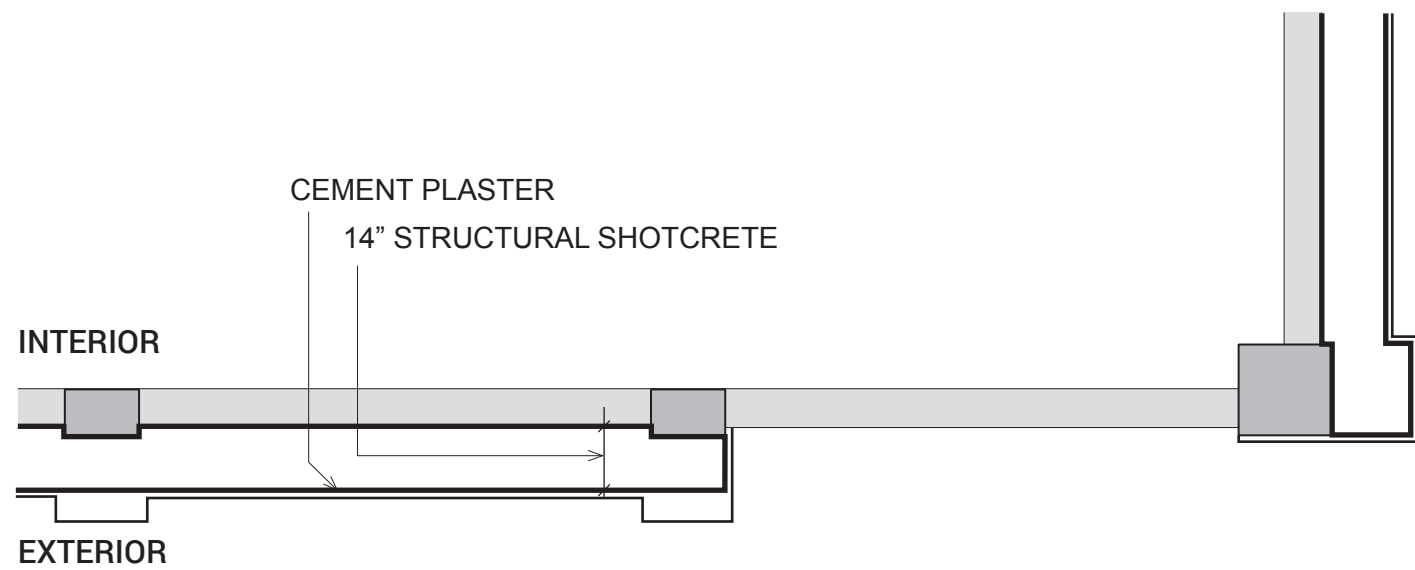

OPTION 3 - Thin Set Abstract Homage

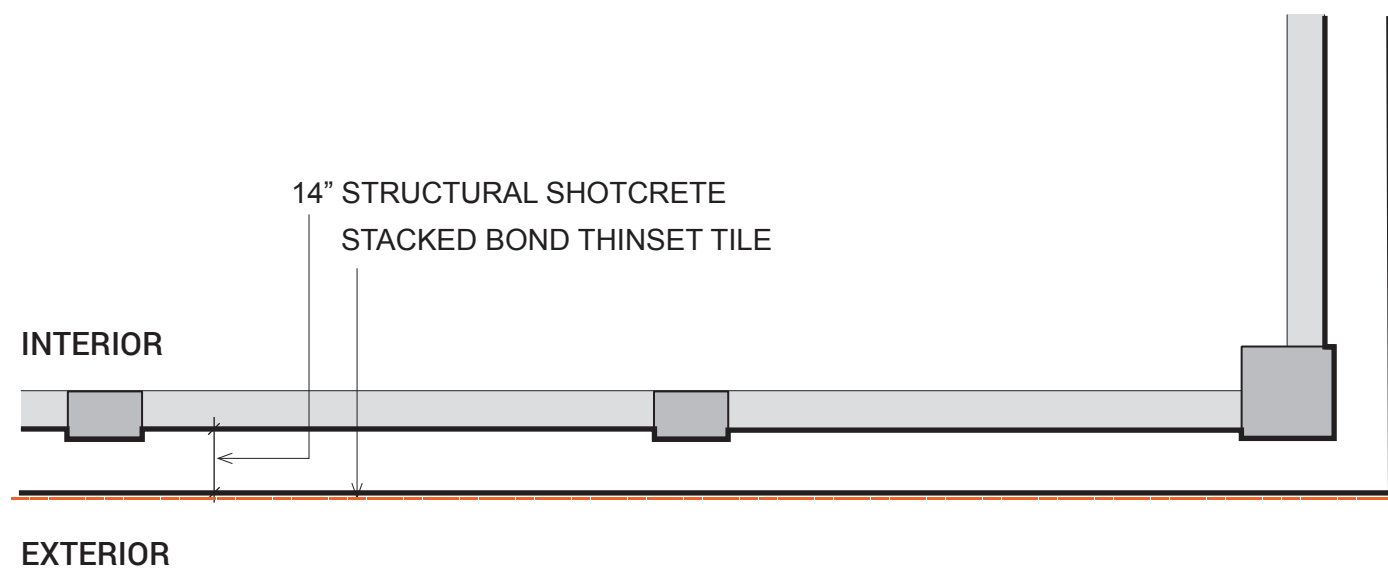
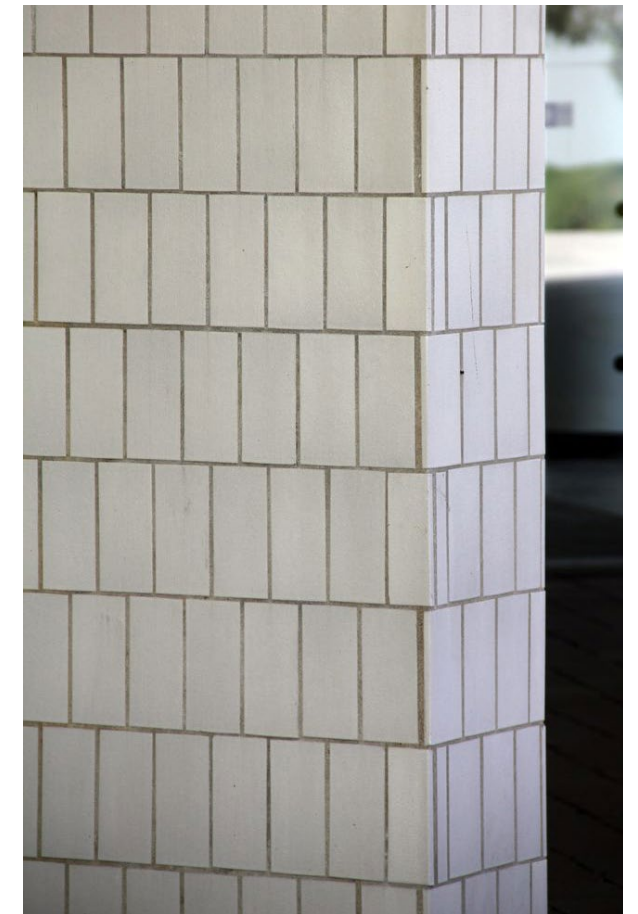

Representative Finish

OPTION 4 - Cast In Place Concrete with Reveals

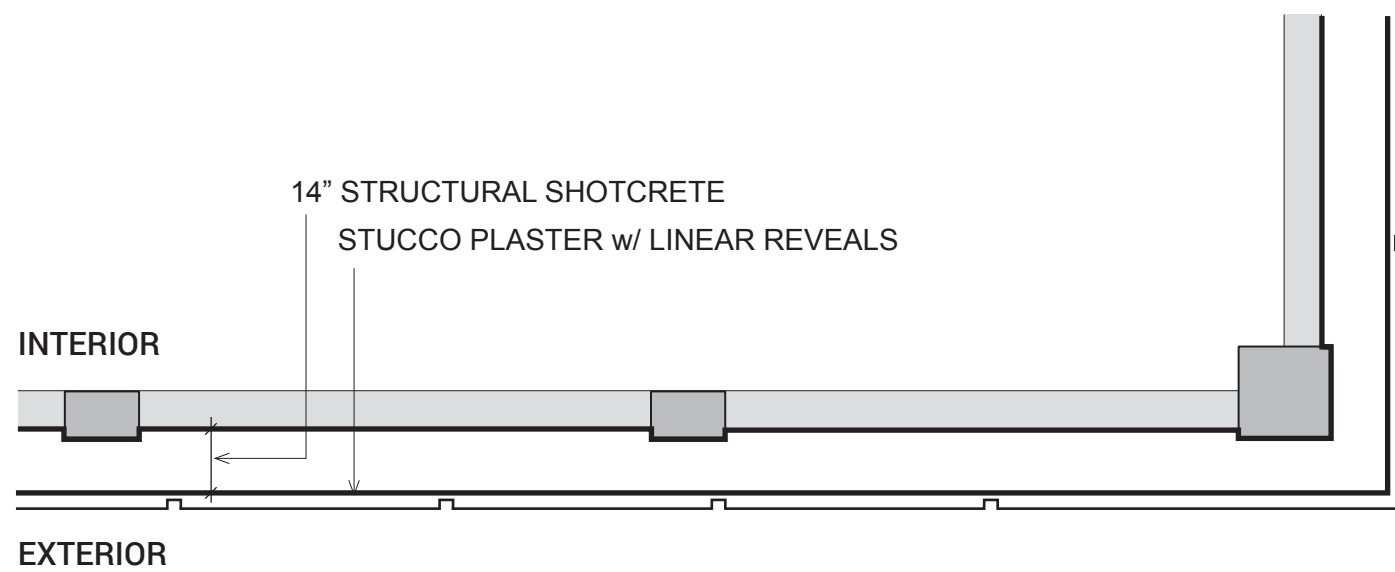
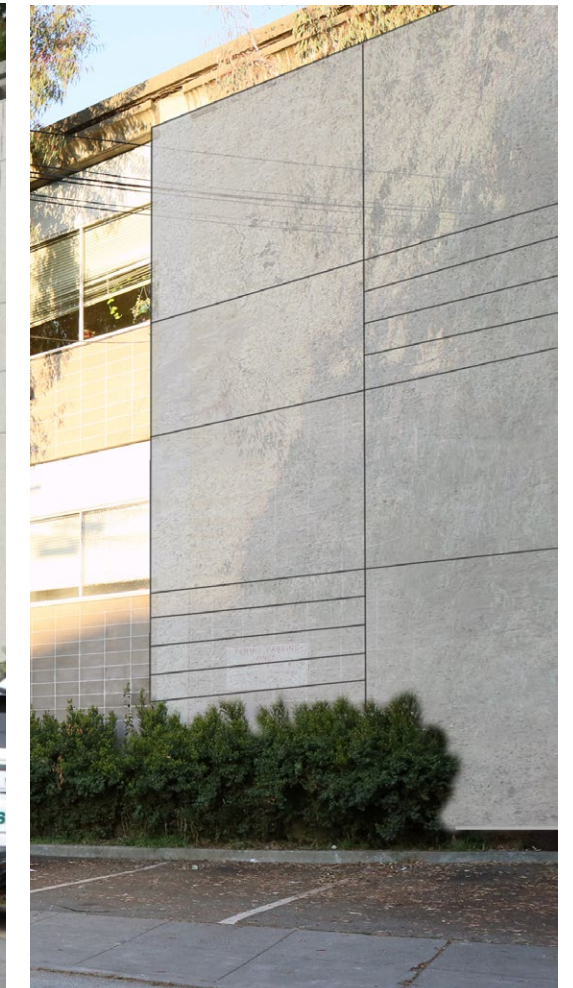

Representative Finish

Design Concepts

OPTION 5 - Cast In Place Concrete with Relief, Nature Motif



OPTION 5 - Cast In Place Concrete with Relief, Abstract Motif

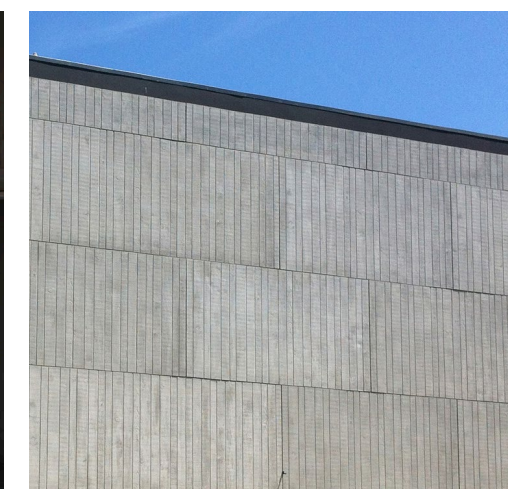
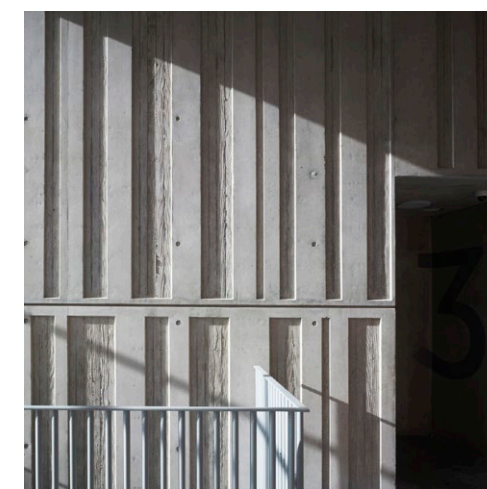
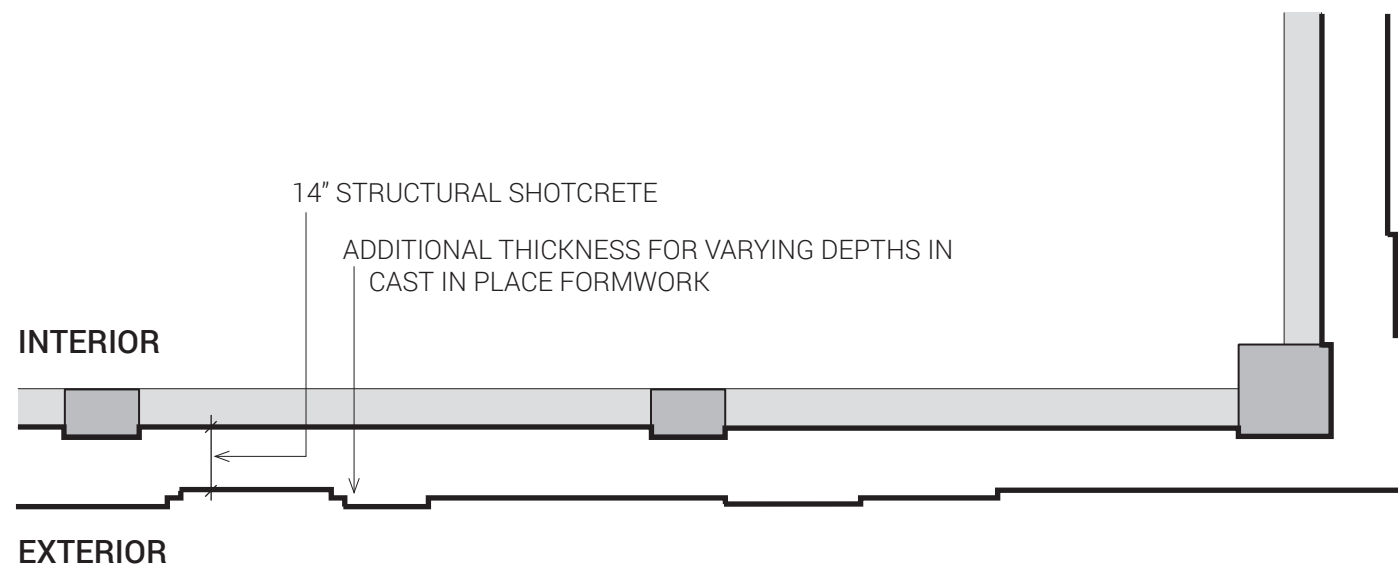

Representative Finish

Design Concepts

Thank You.