



ORIGINAL TAD'S STEAK HOUSE AT 120 POWELL STREET



44 ELLIS STREET
SAN FRANCISCO, CA 94102

UNION SQUARE

GEARY STREET

GRANT AVENUE

STOCKTON STREET

O'FARRELL STREET

EXISTING TAD'S STEAK HOUSE TO BE
RELOCATED TO NEW SPACE AT GROUND
FLOOR OF ELLIS O'FARREL PARKING GARAGE

POWELL STREET

MASON STREET

ELLIS STREET

CYRIL MAGNIN STREET

MARKET STREET

4TH STREET

A. SITE PLAN





B. PROJECT SITE (CURRENTLY LES JOULINES JAZZ BISTRO)



C. ELLIS STREET LOOKING NORTH EAST



D. ELLIS STREET LOOKING EAST



E. ELLIS STREET LOOKING SOUTH WEST

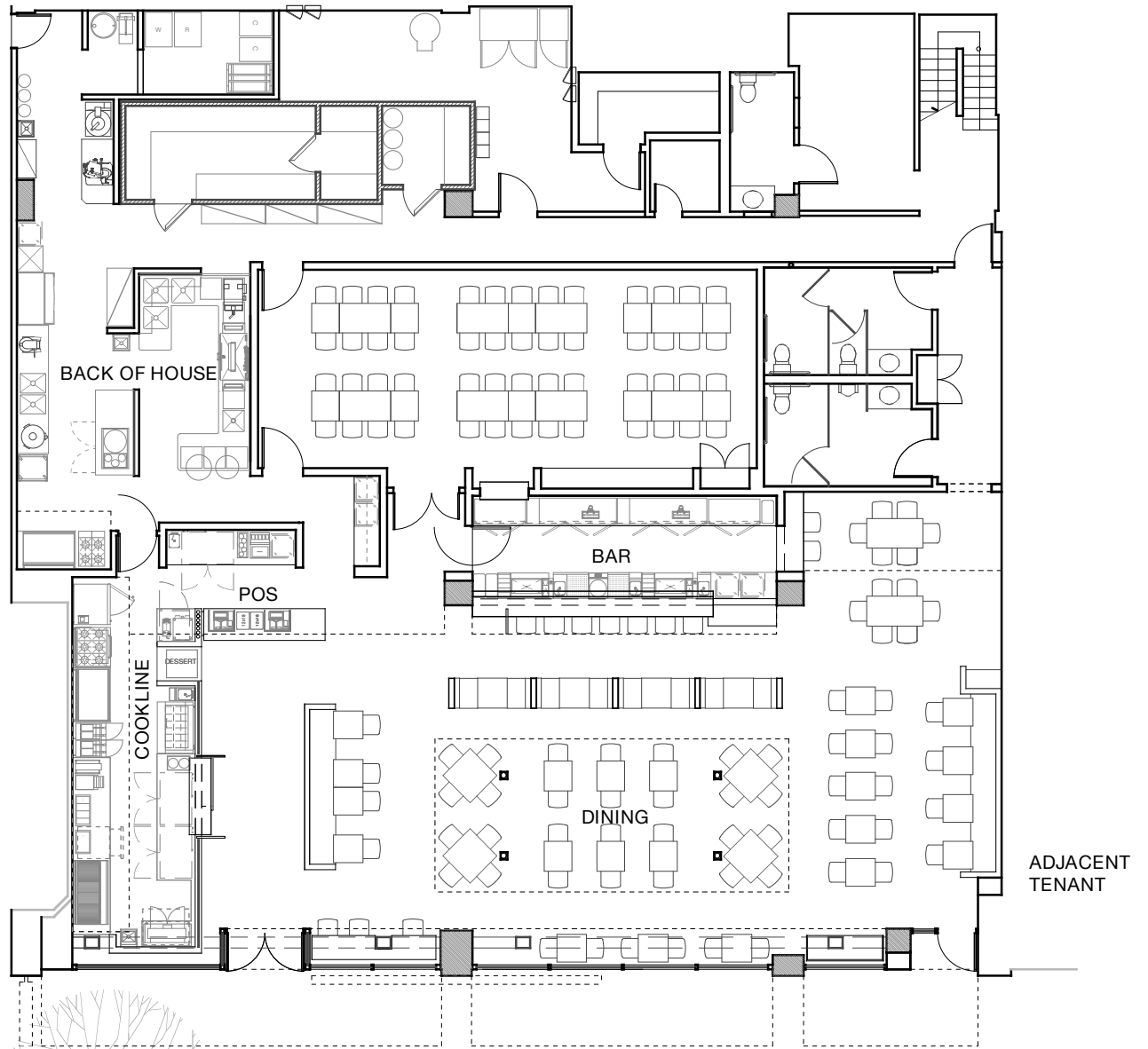

MATERIAL KEY	
(ALU)	ALUMINUM (BRONZE)
(CP)	CEMENT PLASTER
(FB1)	FABRIC (RED)
(FB2)	FABRIC (TAUPE)
(GL1)	GLASS (CLEAR)
(GL2)	GLASS (PATTERNED)

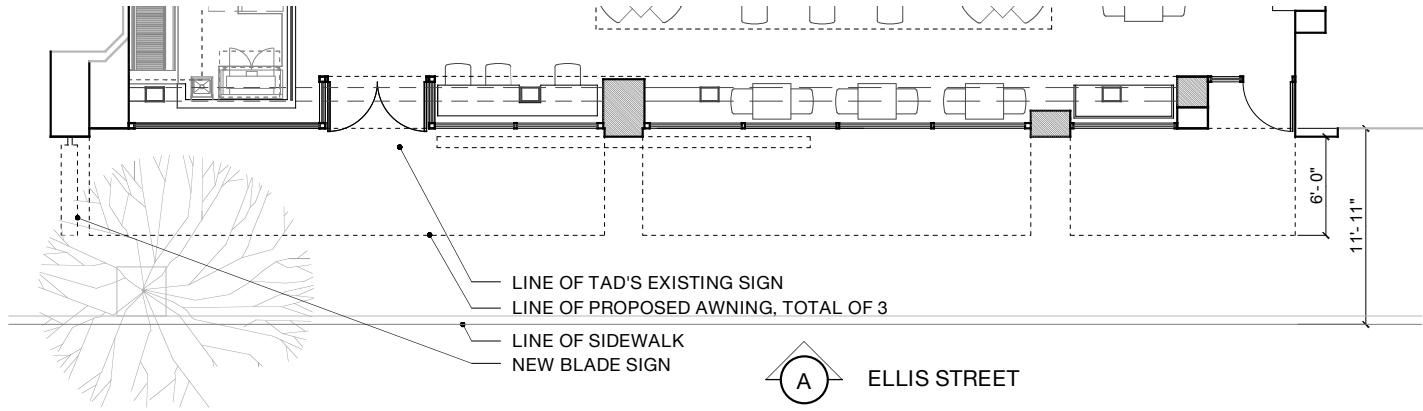

C. PARTIAL PLAN AT STOREFRONT

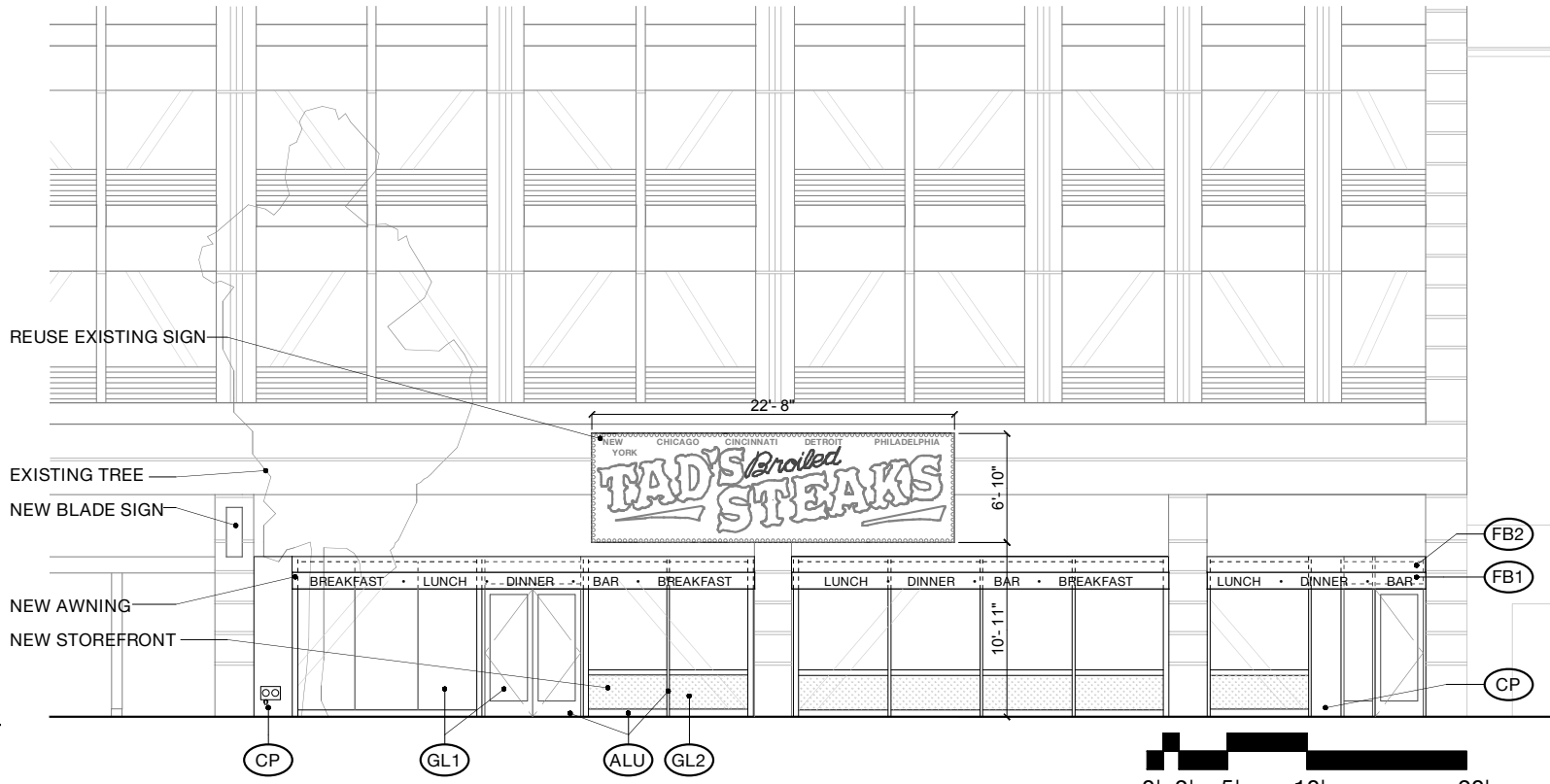

B. BLADE SIGN AND AWNING

A. EXTERIOR ELEVATION

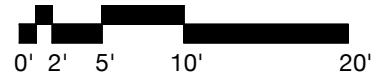



PREVIOUS SUBMITTAL 1: RENDERING 06/19/17

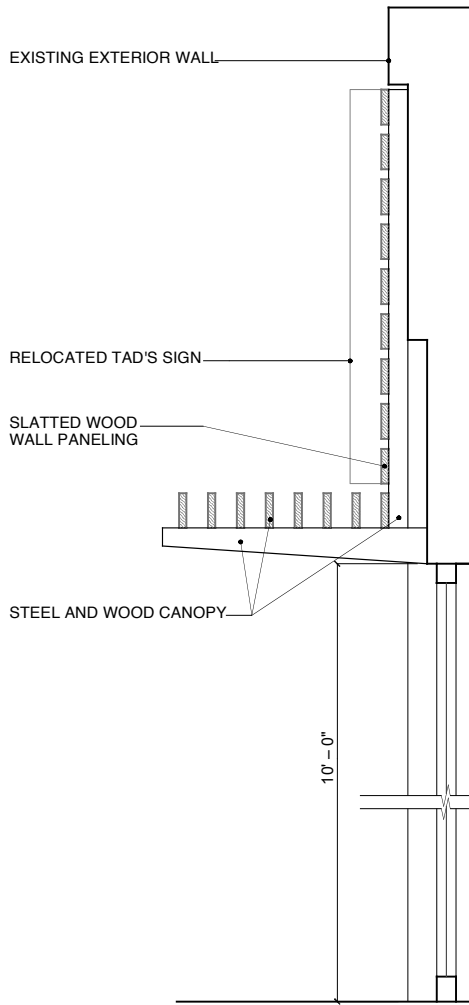

B. ENLARGED PARTIAL SECTION

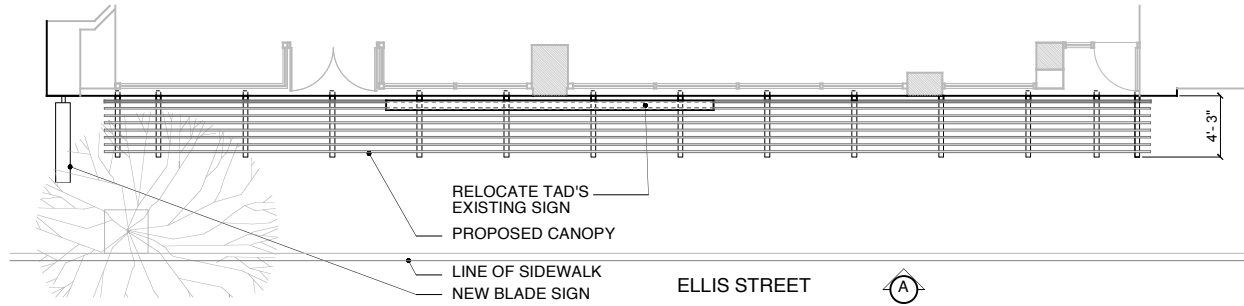
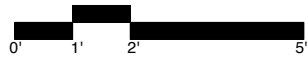

C. ROOF PLAN AT AWNING

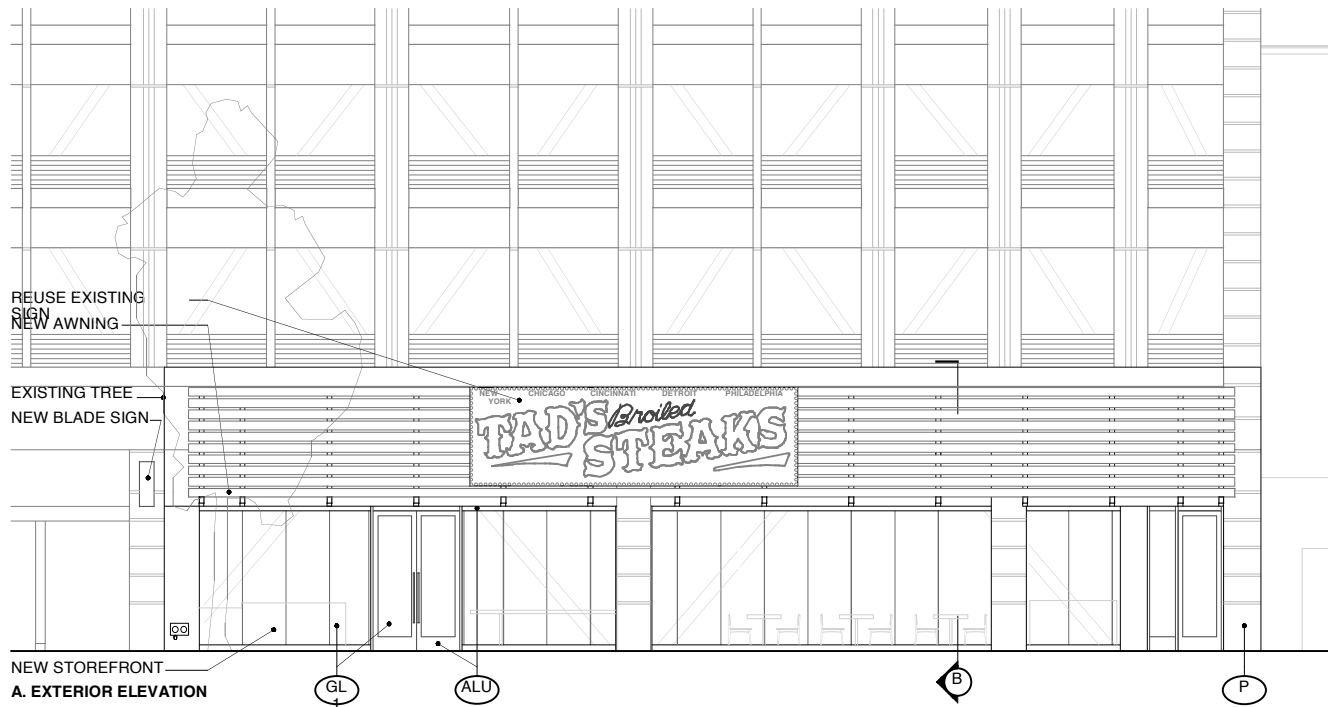

A. EXTERIOR ELEVATION





PREVIOUS SUBMITTAL 2: RENDERING (OPTION A) 07/10/17

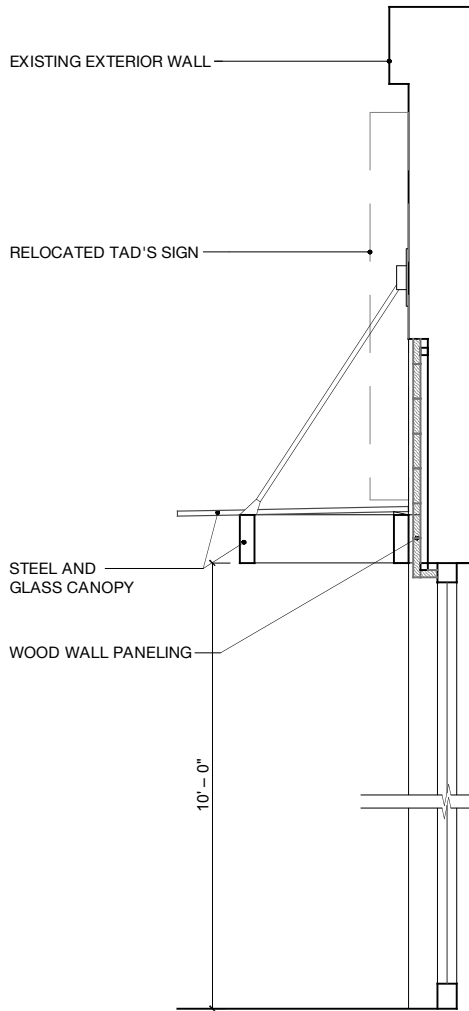

B. ENLARGED PARTIAL SECTION

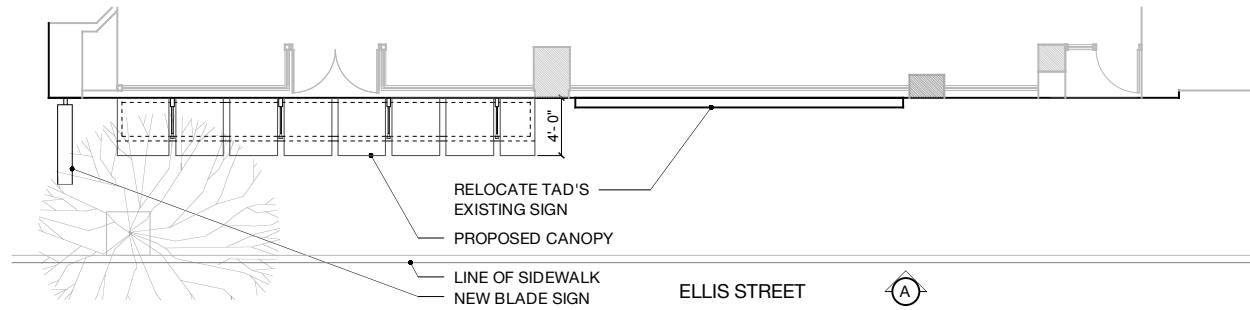

C. ROOF PLAN AT AWNING

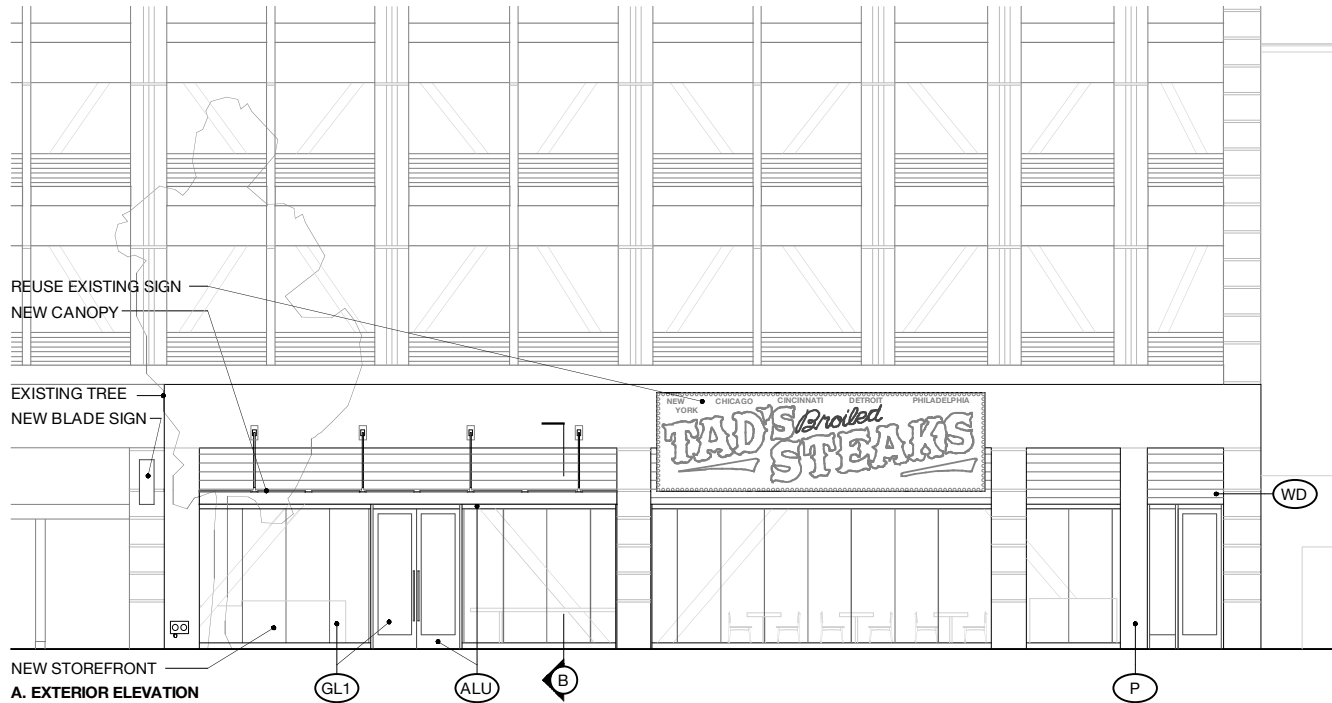

A. EXTERIOR ELEVATION

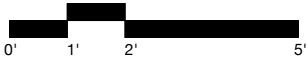



PREVIOUS SUBMITTAL 2: RENDERING (OPTION B) 07/10/17

CURRENT SUBMITTAL PHASE 2 & 3

09/18/17

SHEET INDEX

- DR2-1: GROUND FLOOR PLAN
- DR2-2: EXTERIOR ELEVATION
- DR2-3: SECTION AT ENTRANCE
- DR2-4: ENLARGED STOREFRONT
- DR2-5: PARTIAL SECTIONS
- DR2-6: BLADE SIGN DETAIL
- DR2-7: RENDERING
- DR2-8: MATERIAL BOARD

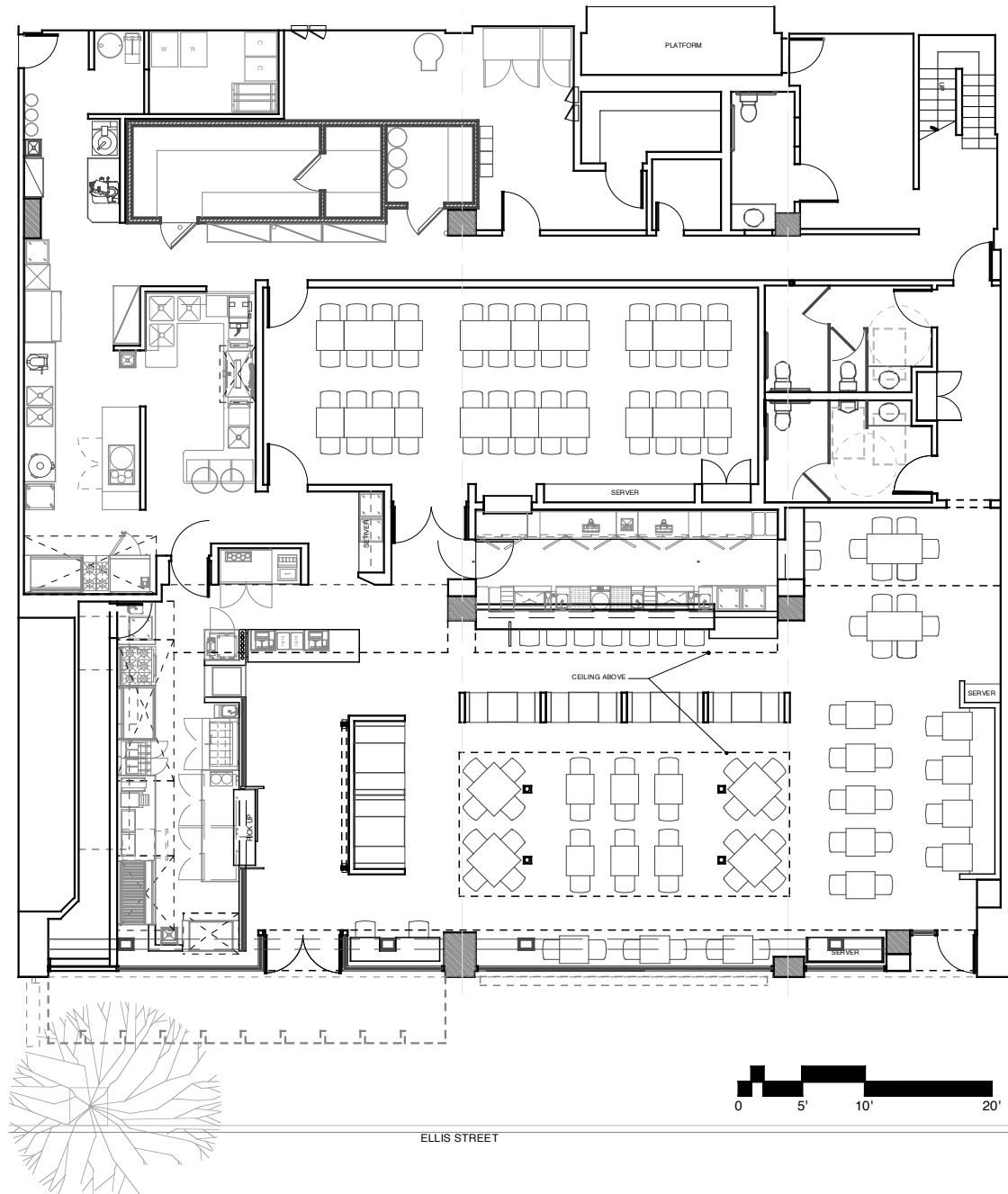

MATERIAL KEY	
ALU	ALUMINUM (BRONZE)
GL1	GLASS (CLEAR)
GL2	GLASS (FROSTED)
P	PAINT (TAUPE)
ST1	STEEL (PAINTED)
WD	WOOD

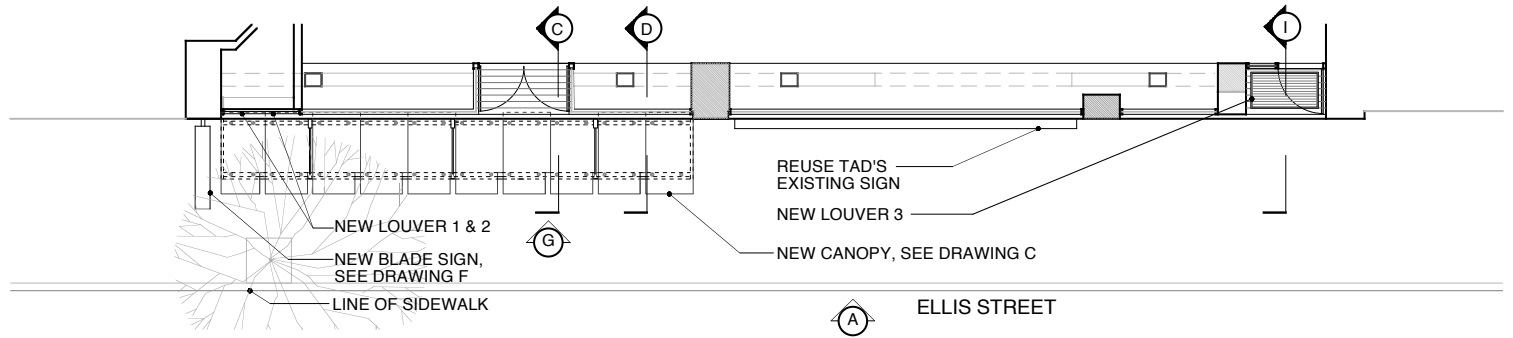

B. REFLECTED CEILING PLAN AT STOREFRONT



A. EXTERIOR ELEVATION



MATERIAL KEY	
ALU	ALUMINUM (BRONZE)
GL1	GLASS (CLEAR)
GL2	GLASS (FROSTED)
P	PAINT (TAUPE)
ST1	STEEL (PAINTED)
WD	WOOD

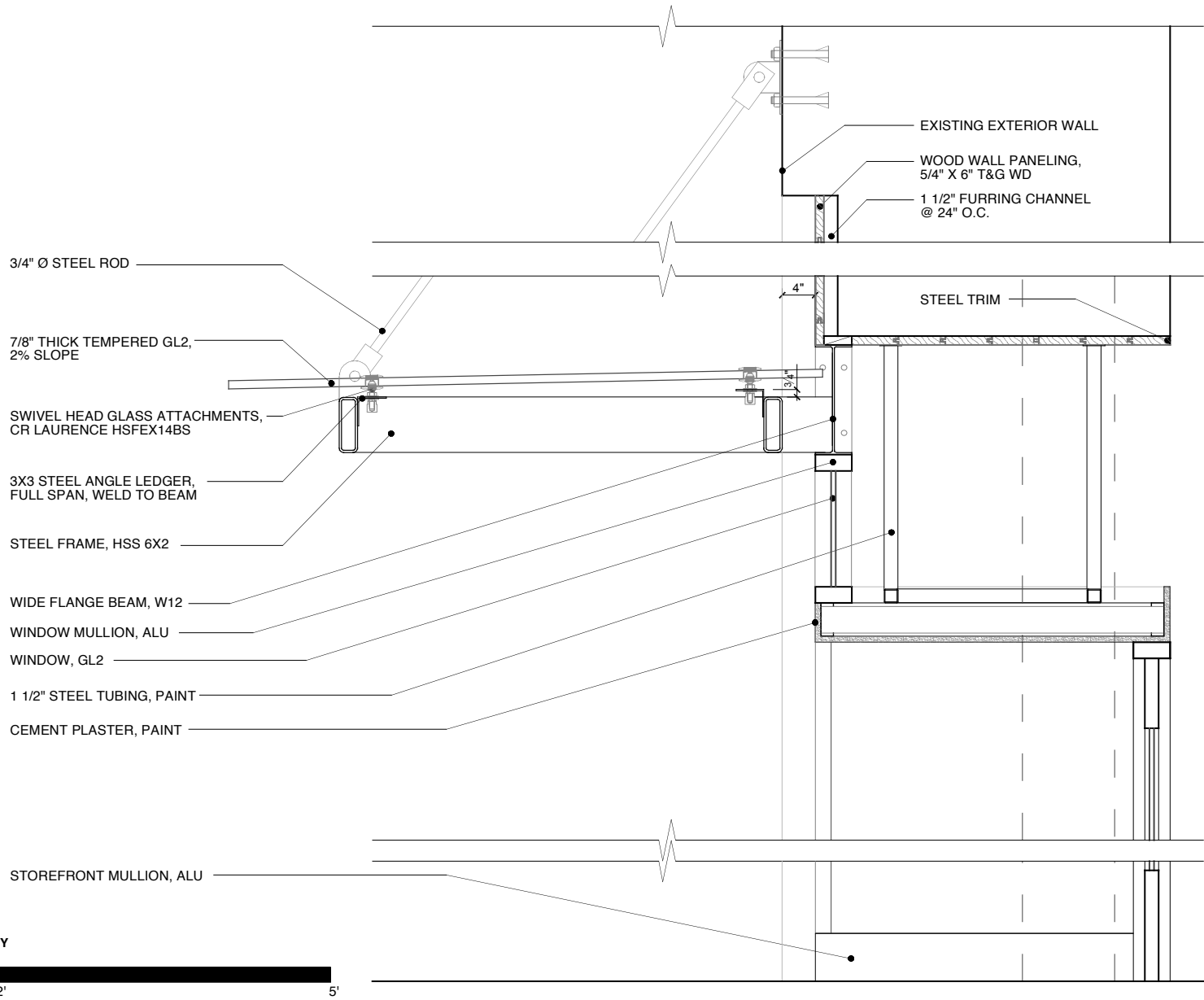

SECTION AT ENTRANCE

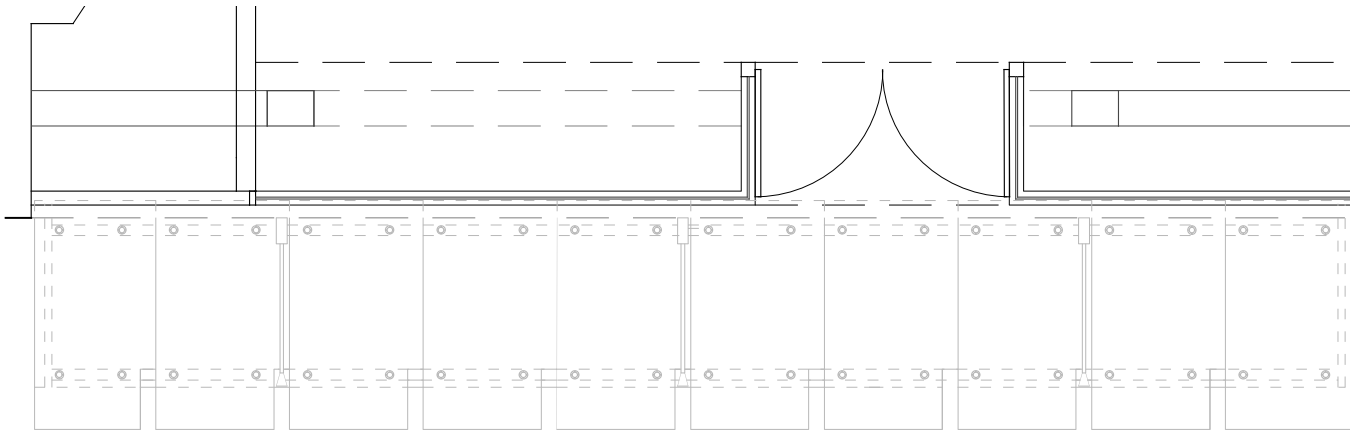

H. ENLARGED PLAN

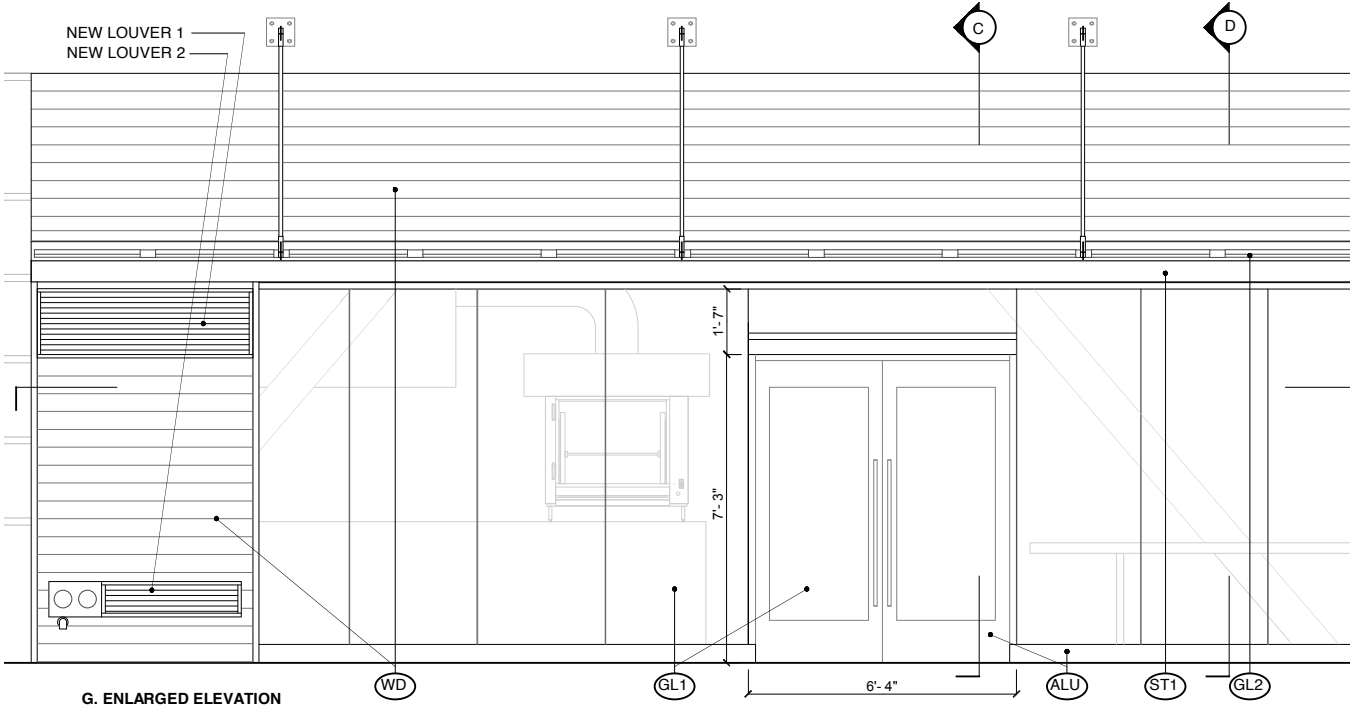

G. ENLARGED ELEVATION

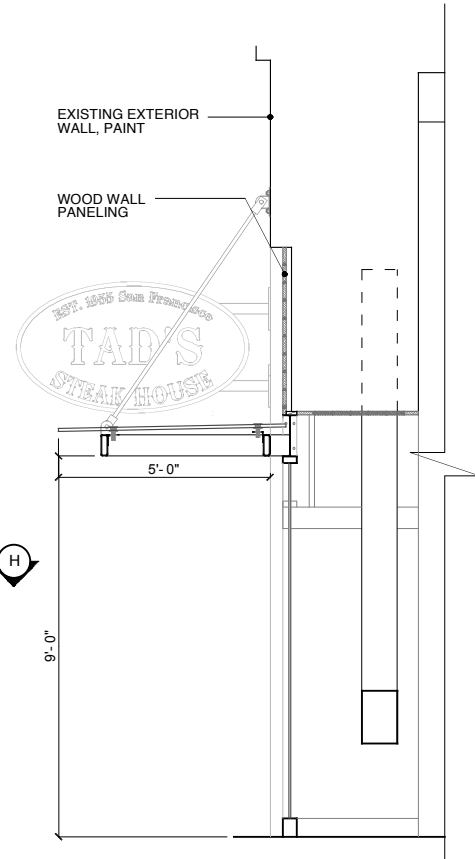

D. ENLARGED PARTIAL SECTION

ENLARGED STOREFRONT

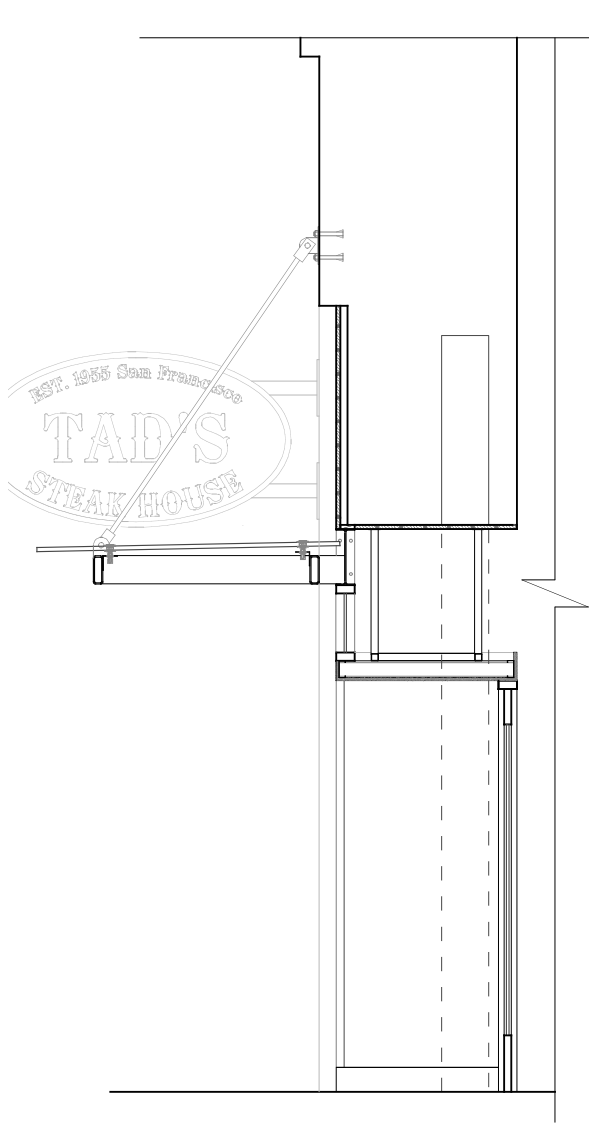

C. PARTIAL SECTION

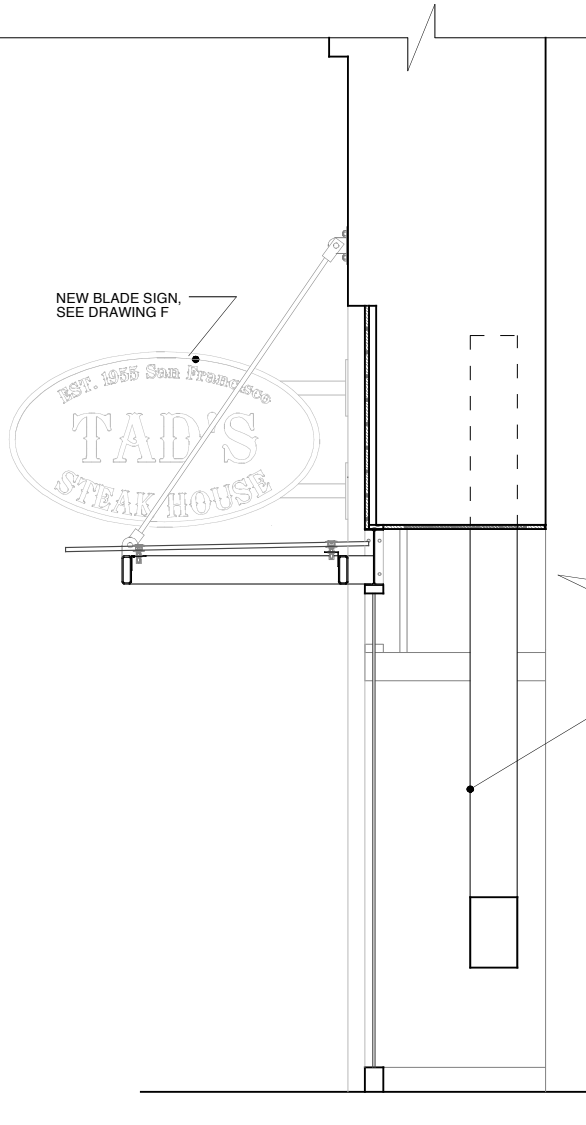

D. PARTIAL SECTION

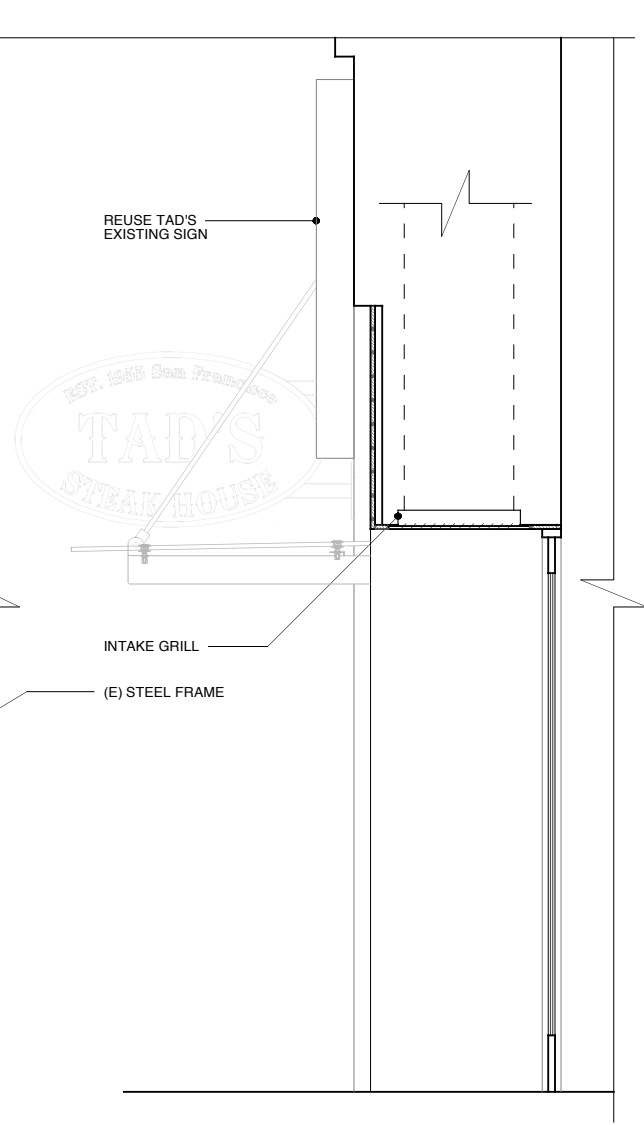

I. PARTIAL SECTION

MATERIAL KEY	
(ALU)	ALUMINUM (BRONZE)
(GL1)	GLASS (CLEAR)
(GL2)	GLASS (FROSTED)
(P)	PAINT (TAUPE)
(ST1)	STEEL (PAINTED)
(WD)	WOOD

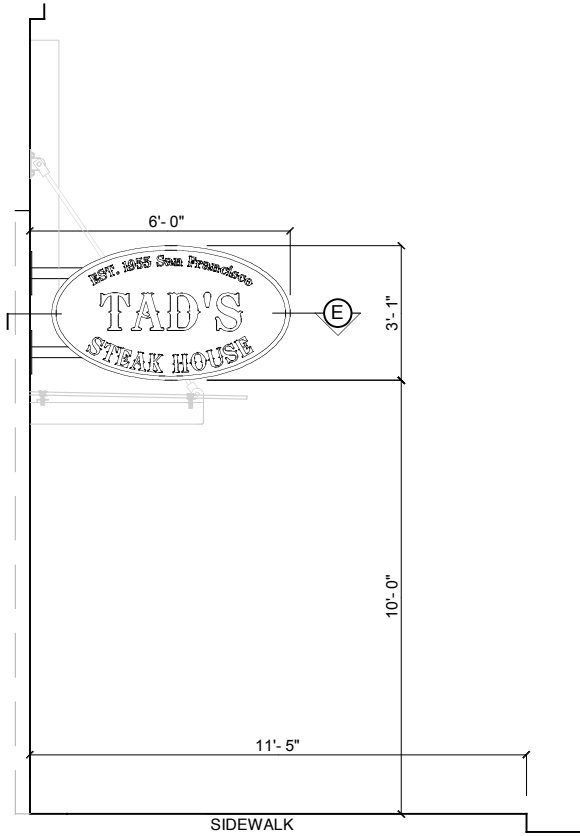

F. BLADE SIGN ELEVATION

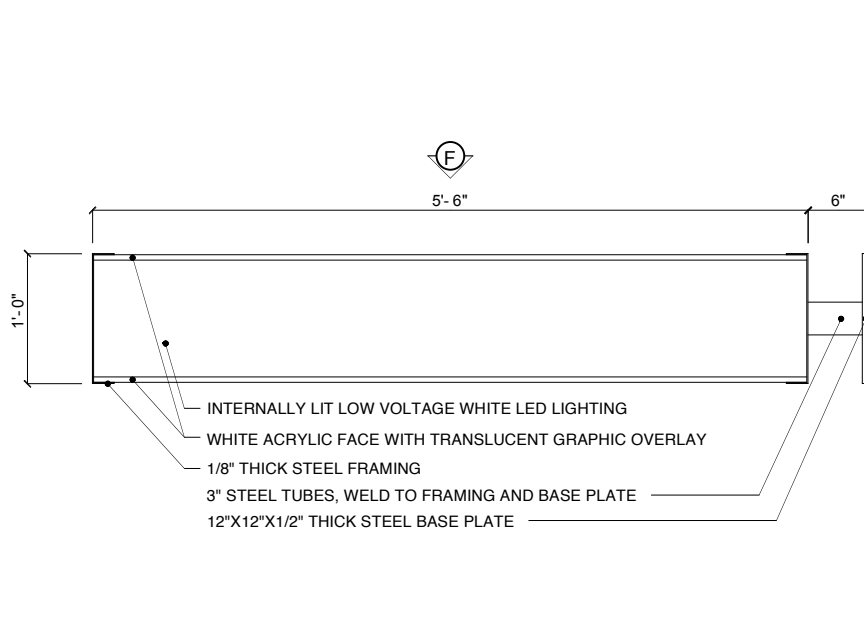

E. SECTION DETAIL - BLADE SIGN





RENDERING

DR2-7

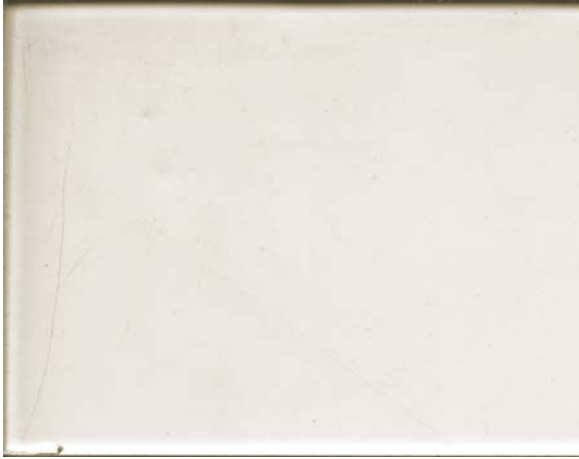

GL1 GLASS (CLEAR)



ALU ALUMINUM (BRONZE)



WD WOOD



GL2 GLASS (FROSTED)



ST1 STEEL (PAINTED)



P PAINT (TAUPE)