

**SFMTA**

Municipal Transportation Agency



**SFMTA OPERATOR'S RESTROOM AT  
PHELAN AVENUE NEAR  
OCEAN AVENUE  
PHASE I  
REVIEW**

02 | 13 | 2012 | SAN FRANCISCO, CALIFORNIA

# **SFMTA Operator's Restroom and Sound Wall *Project Goals***

**Replace the existing Phelan Loop Operator's restroom which will be demolished as part of the SFMTA new Phelan Loop Project**

- **Provide men's and women's restroom**
- **Provide design consistent with SFMTA's architectural language**
- **Integration with Phelan Loop Development project & surrounding area**
- **Enrich site's landscaping**
- **Sound Wall to separate the bus loop from the fire station**

# Vicinity Map



# Phelan Loop Operator's Restroom and Sound Wall Phase I Review

- **Phelan Loop Neighborhood Context Plan**
  - **Restroom Design: Higher Height & Canopy Development**
    - **Sound Wall Design**

# Current Phelan Loop Area



Aerial photo of existing Phelan Loop Area, 3/30/2010

# Phelan Loop Neighborhood Context Plan



# Existing Site and Surrounding Area



PHELAN AVENUE CITY COLLEGE



PHELAN AVENUE CITY COLLEGE



PHELAN AVENUE FIRE STATION



OCEAN AVENUE

# Architectural Reference

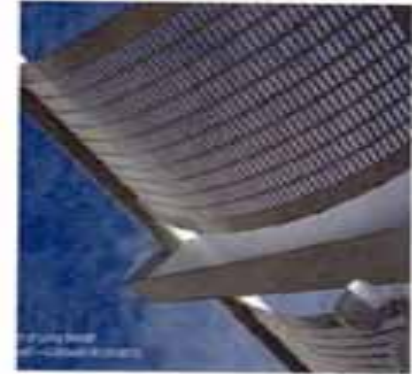



# Sketches Illustration of Design Progression

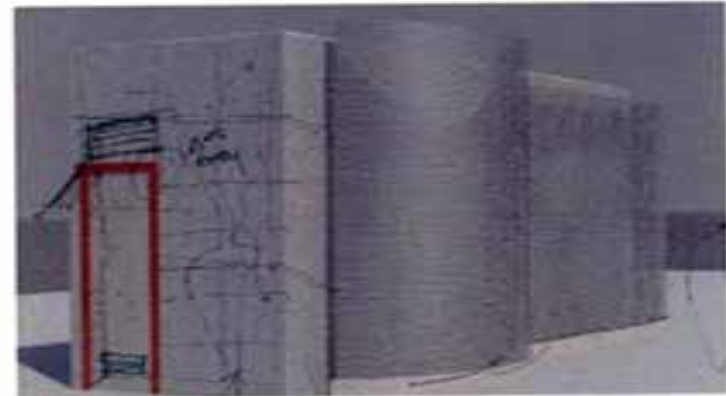
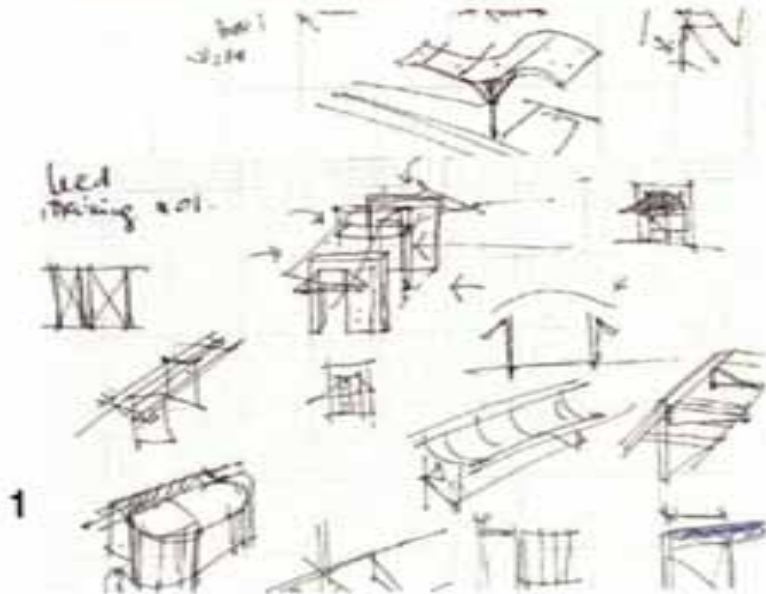
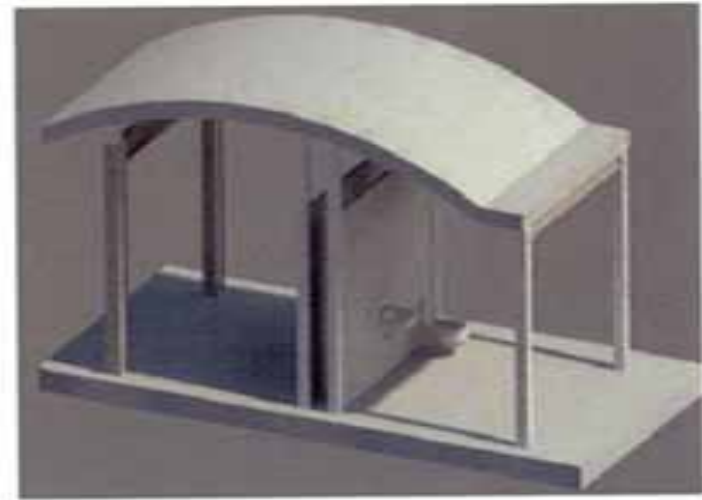
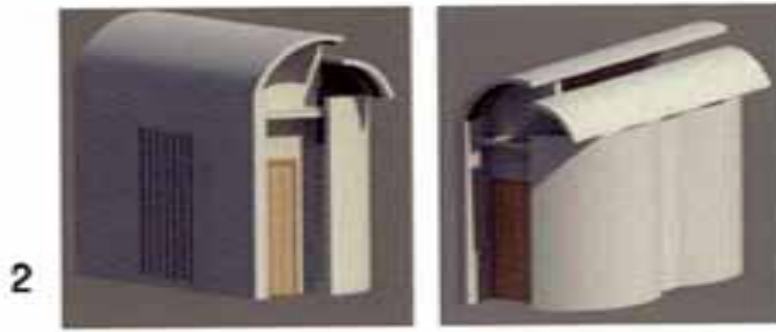

# Construction Materials

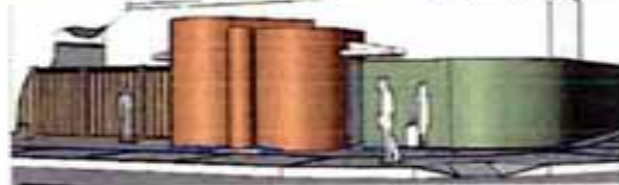

Materials of construction Metals Panels



# Construction Materials

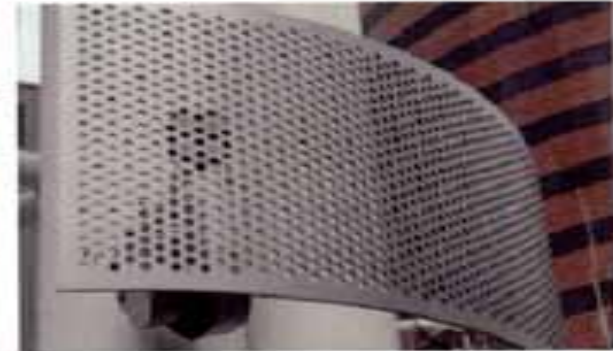
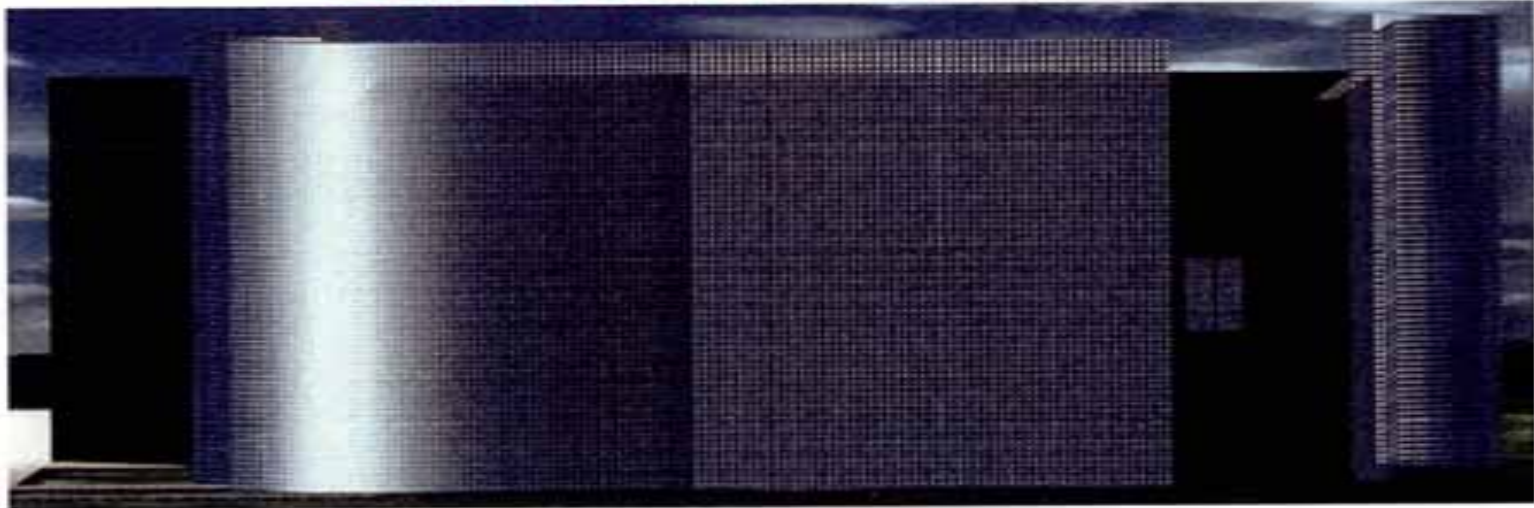

Materials of construction    Perforated Metals Panels

# Floor Plan

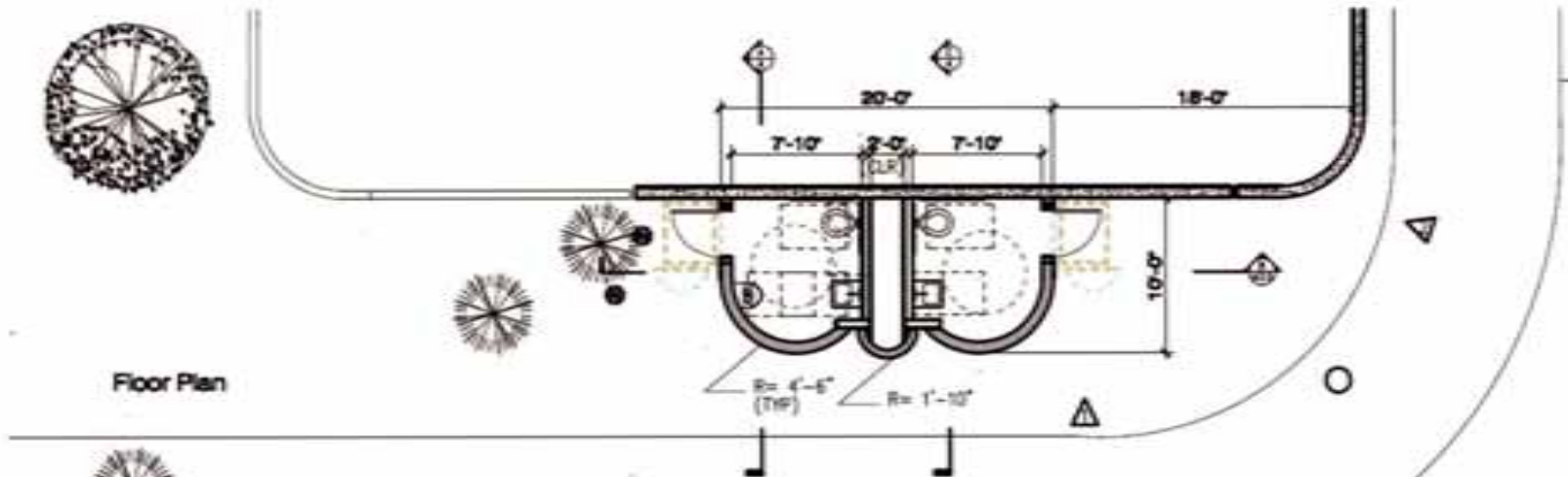

Floor Plan



View 1



View 2

# Operator Restroom Revised Design



# Operator Restroom Revised Design



# New Sound Wall with Site Plan

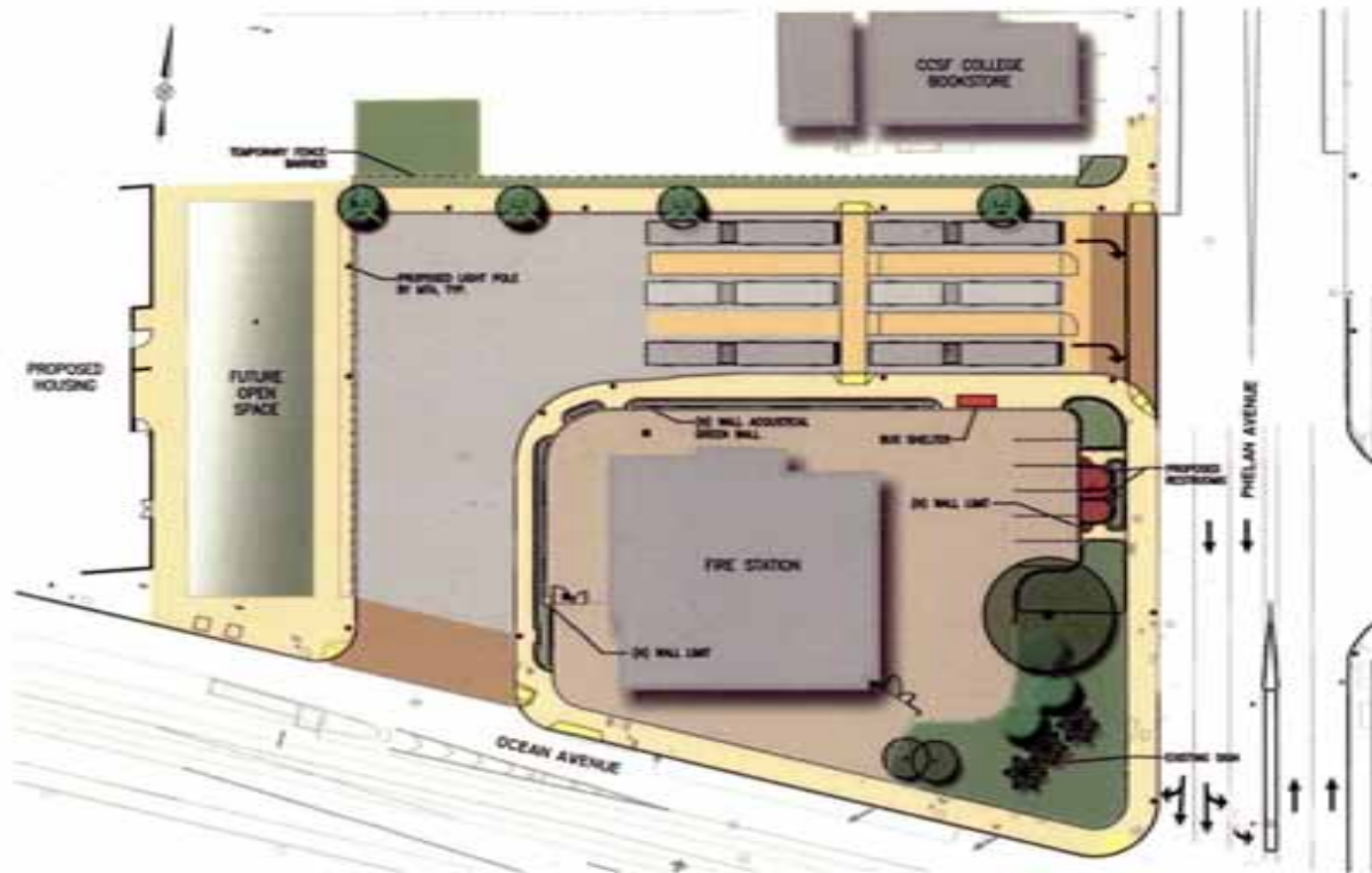

# Phelan Loop Sound Wall

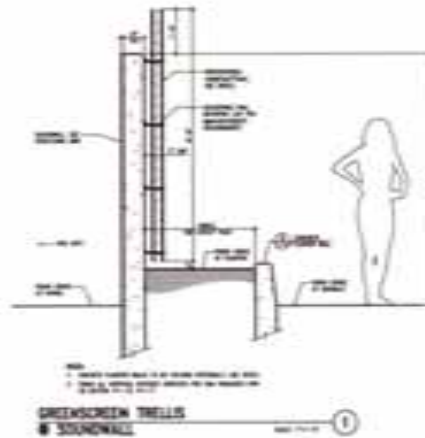



# Phelan Loop Sound Wall



# Phelan Loop Sound Wall

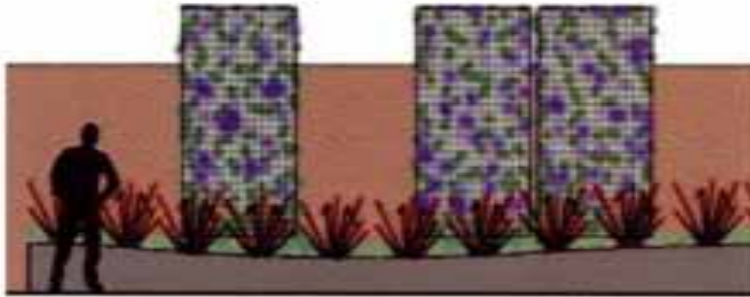

# Phelan Loop Plants



*Arbutus marina*  
Strawberry  
Tree

**Thank you!**

**Discussion and Questions**