

SFMTA | UCSF platform modification
CIVIC DESIGN REVIEW - INFORMATIONAL PRESENTATION - JULY 18th 2016

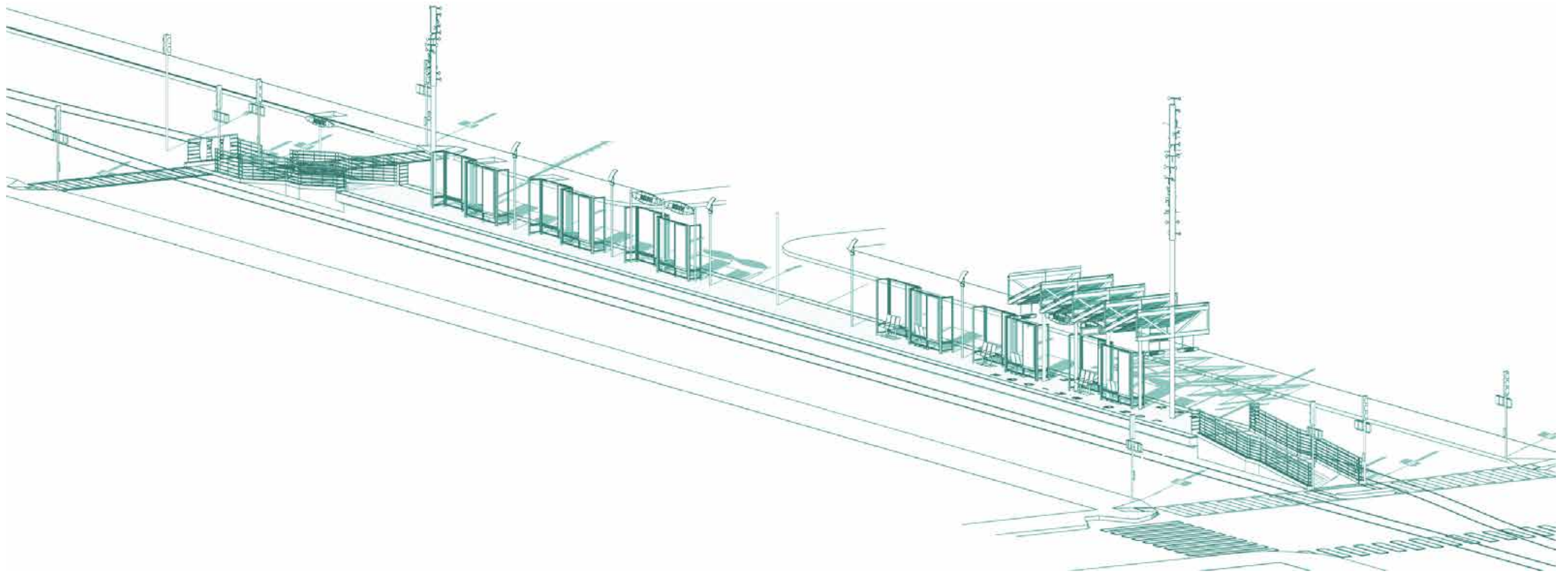

"T - LINE" MAP

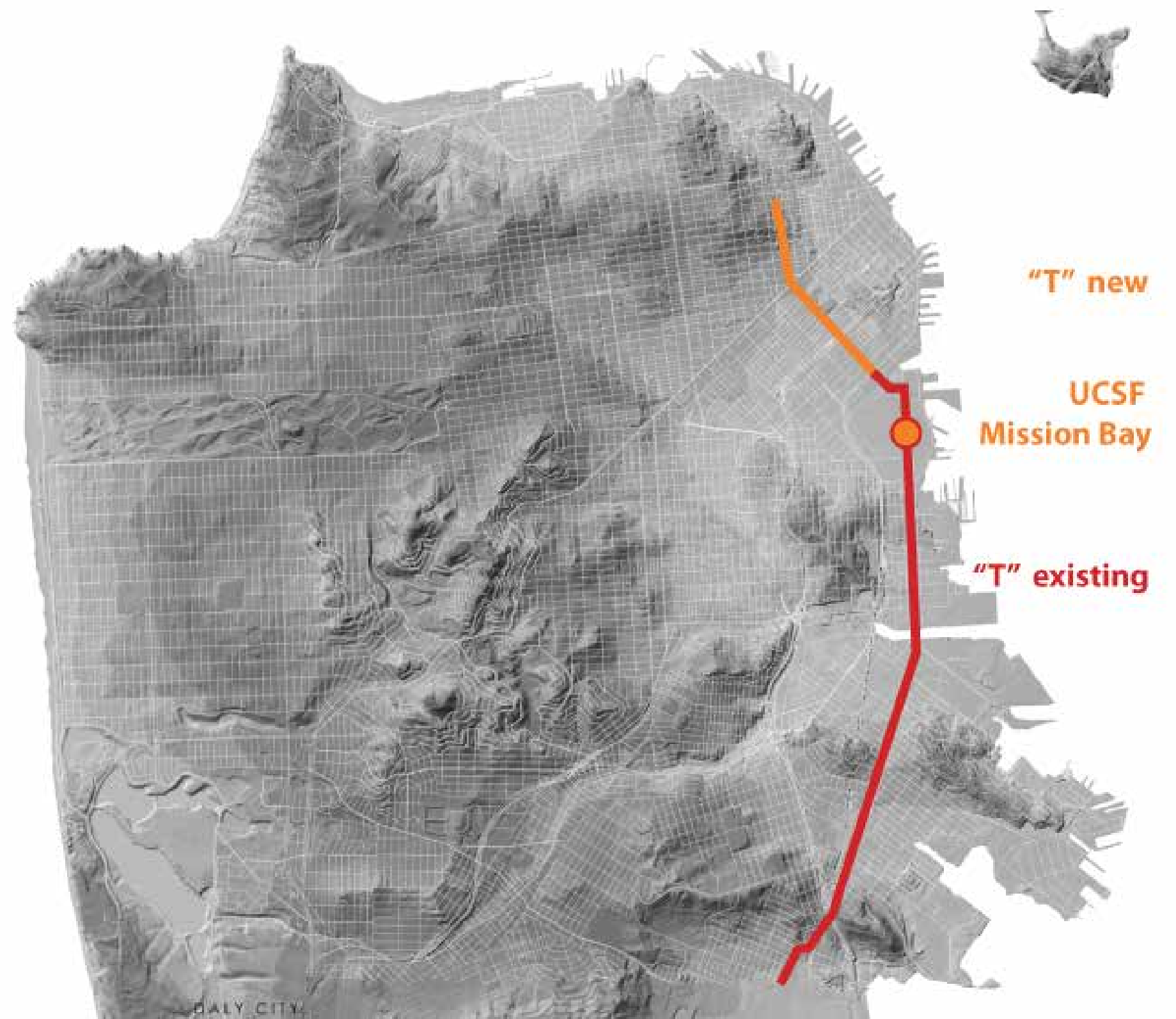

"T - LINE" DIAGRAM

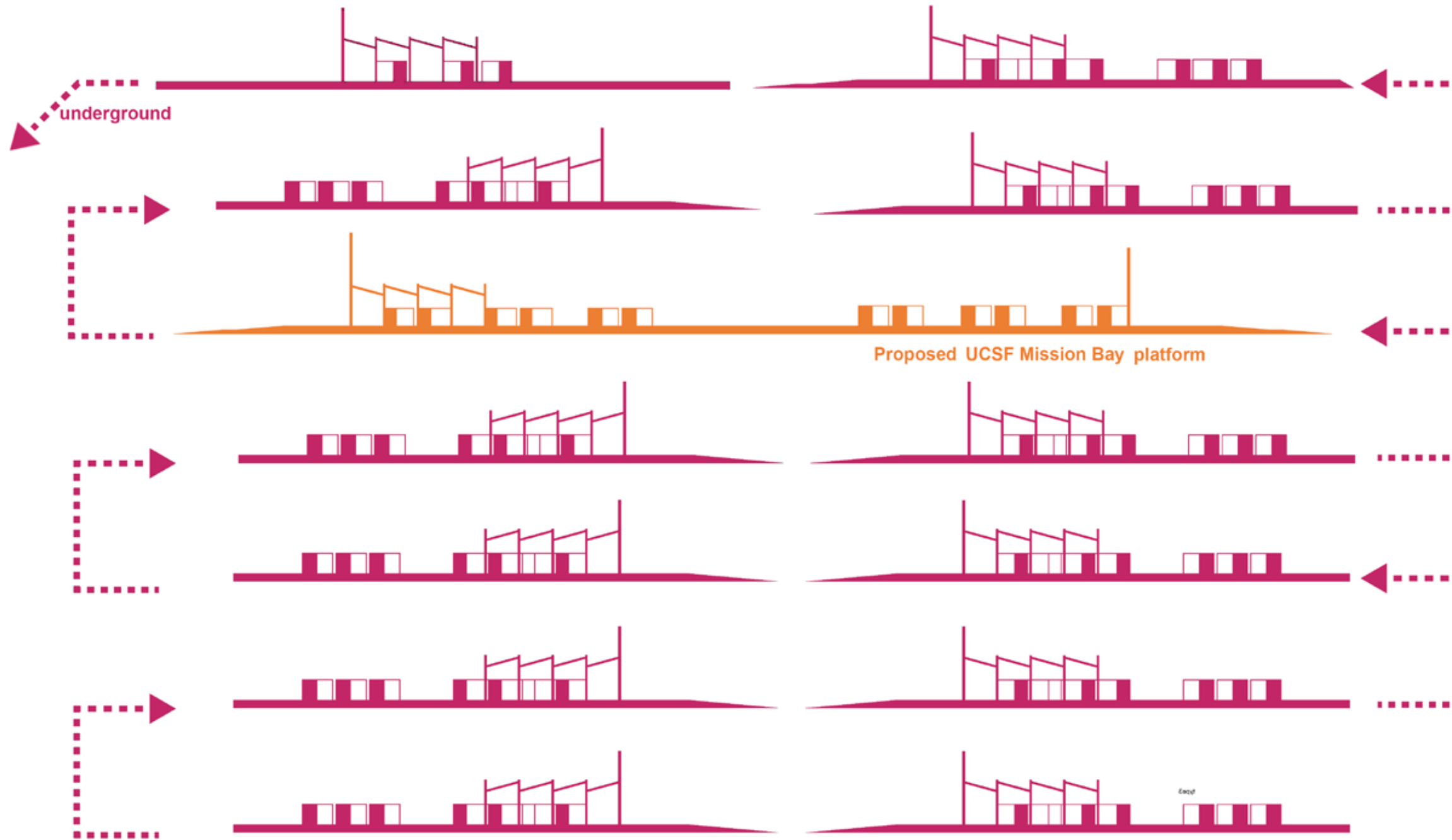

URBAN CONTEXT

EXISTING - LOOKING SOUTH



PROPOSED DEVELOPMENT - VIEW SOUTH



EXISTING - LOOKING NORTH



PROPOSED DEVELOPMENT - VIEW NORTH



SITE MAP



EXISTING PLATFORMS

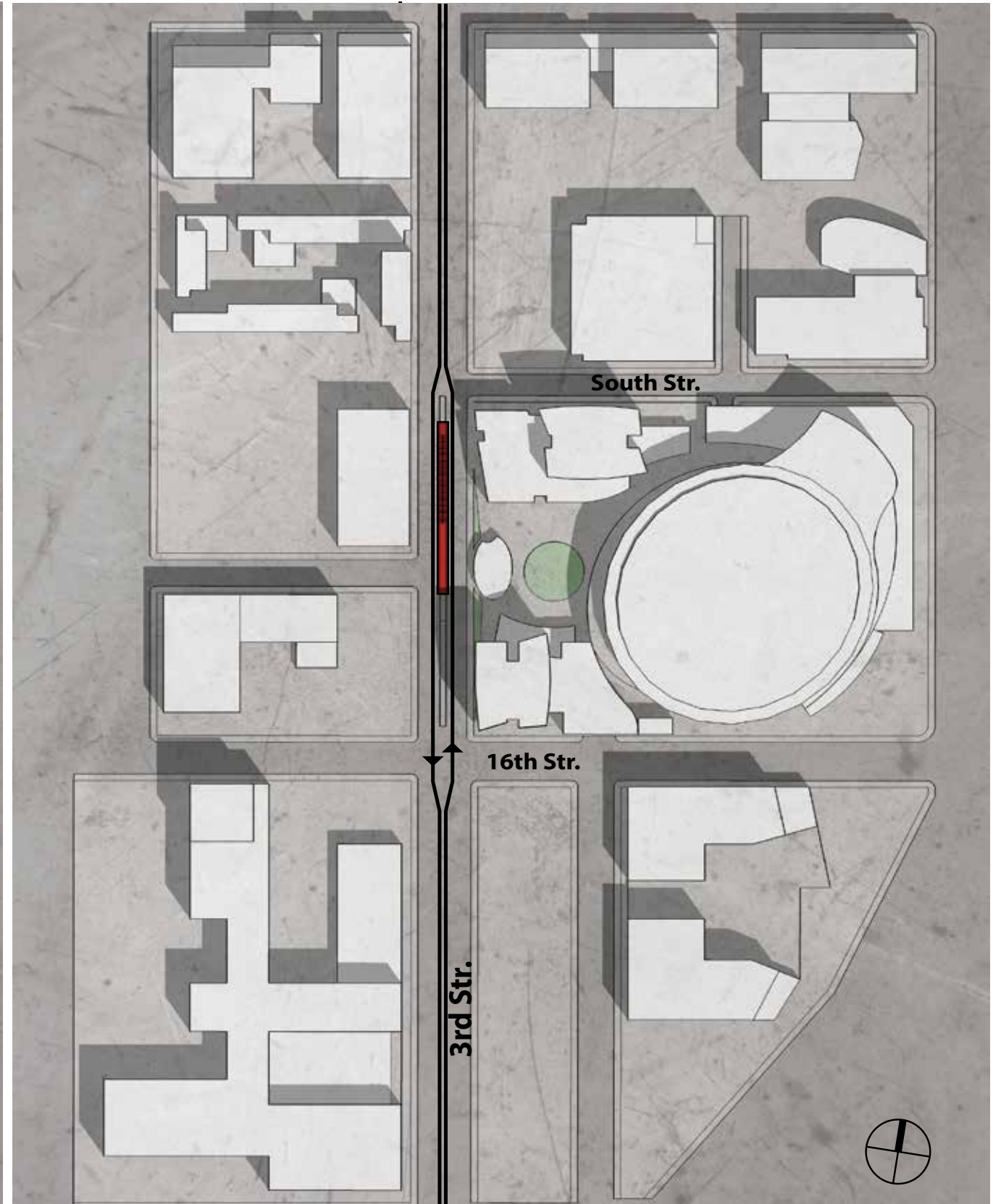

PROPOSED PLATFORM

PROPOSED PLATFORM - DIAGRAM

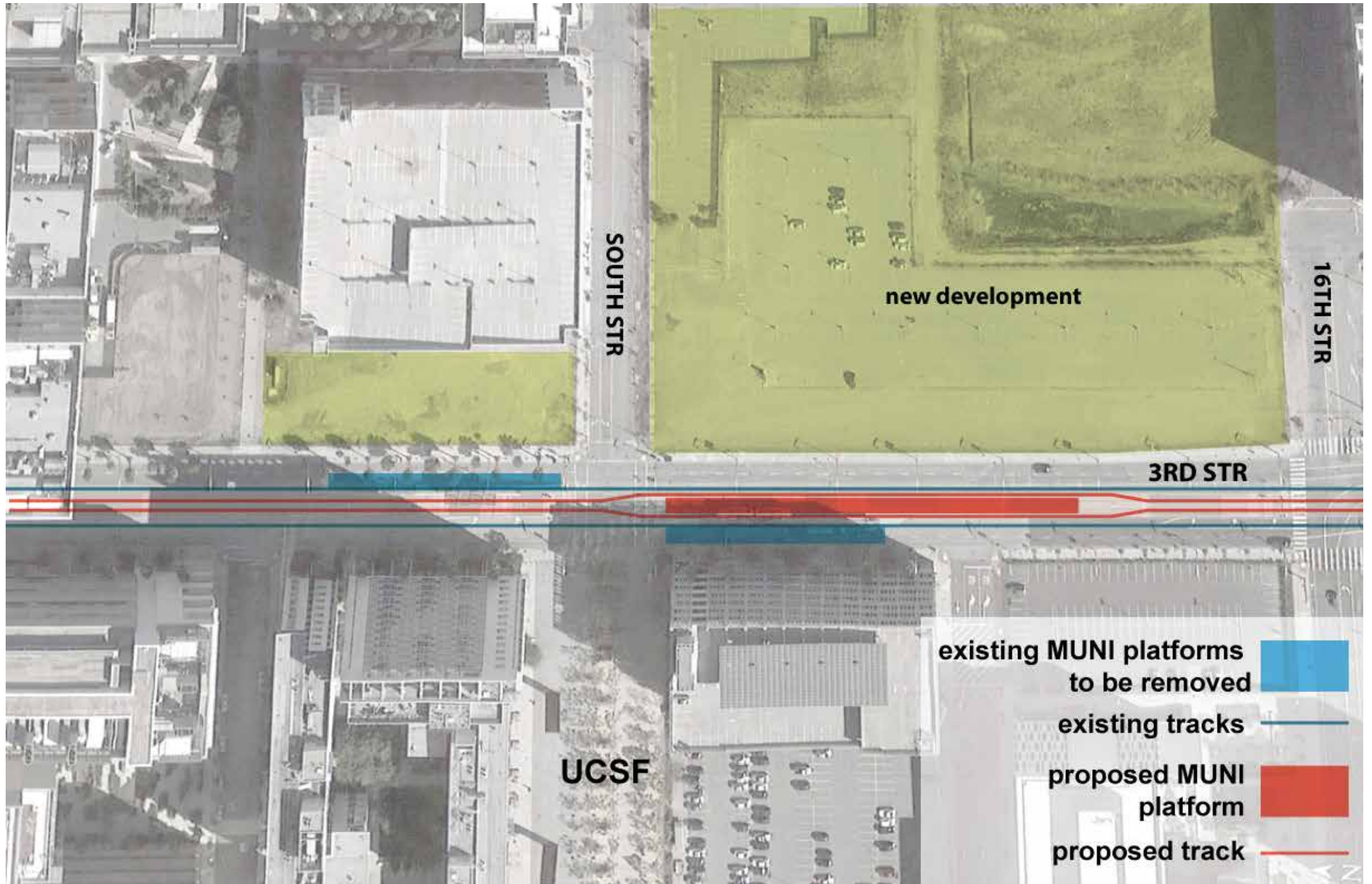

SITE PLAN



PLATFORM - ELEVATION AND PLANS

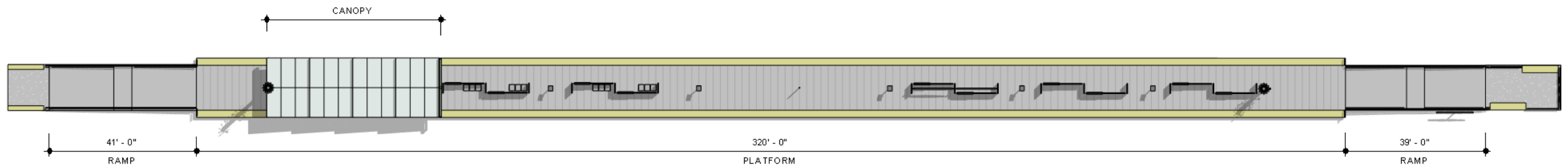
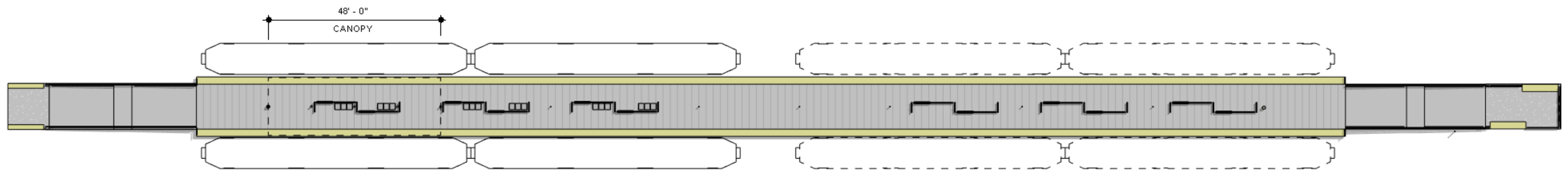
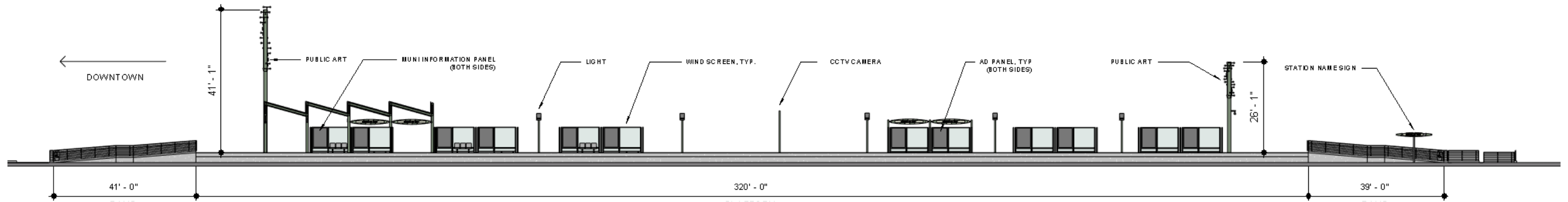

SECTION E-W

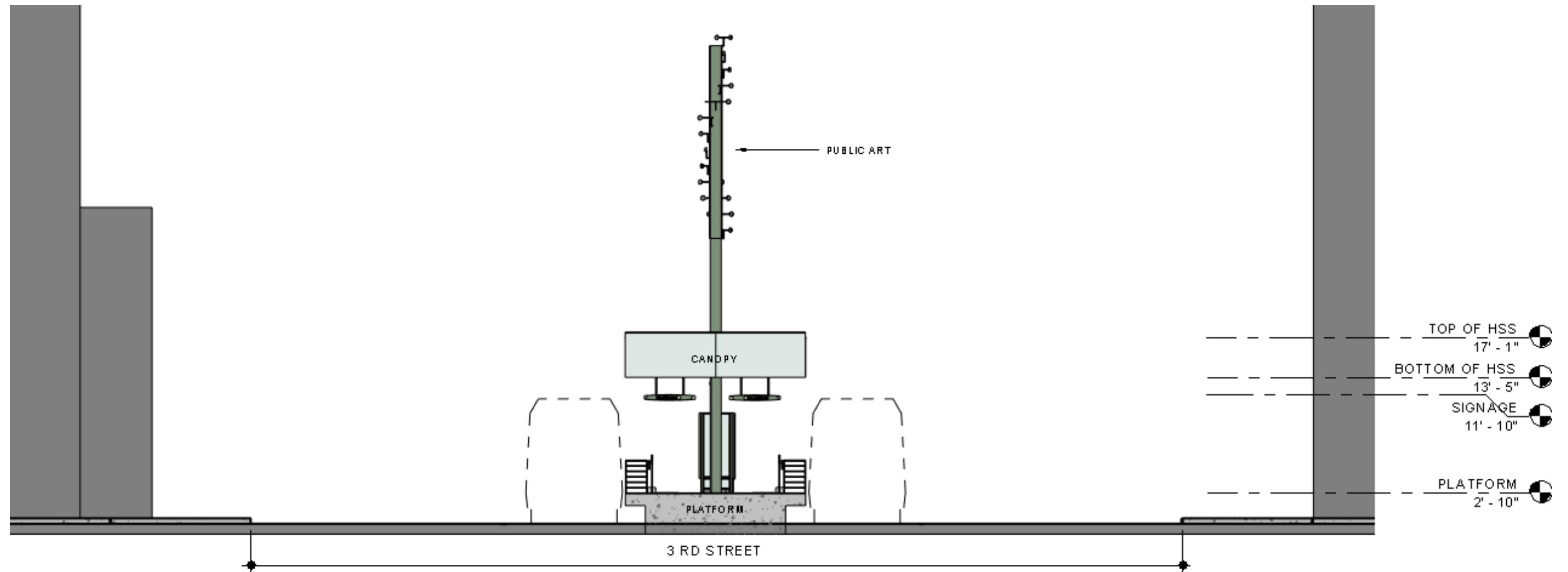

AXONOMETRIC VIEW

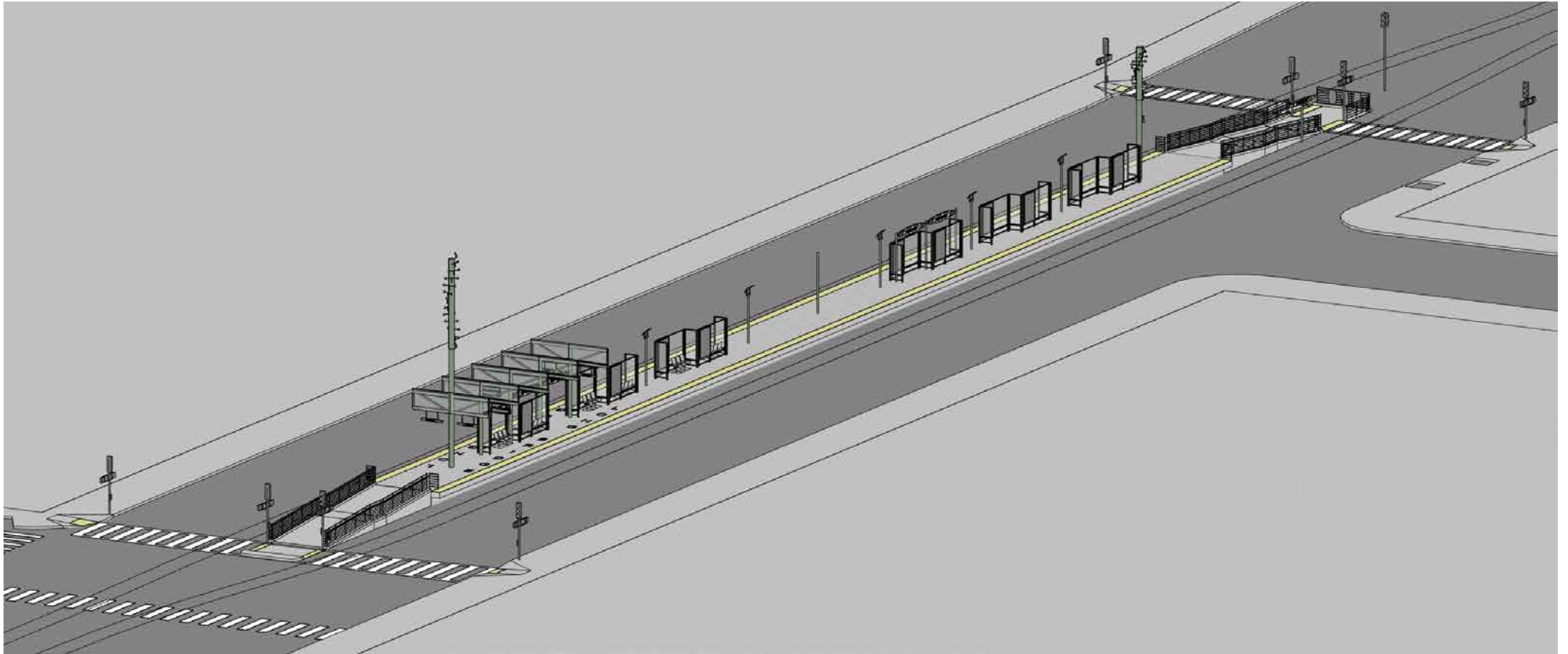

AREA - AERIAL VIEW

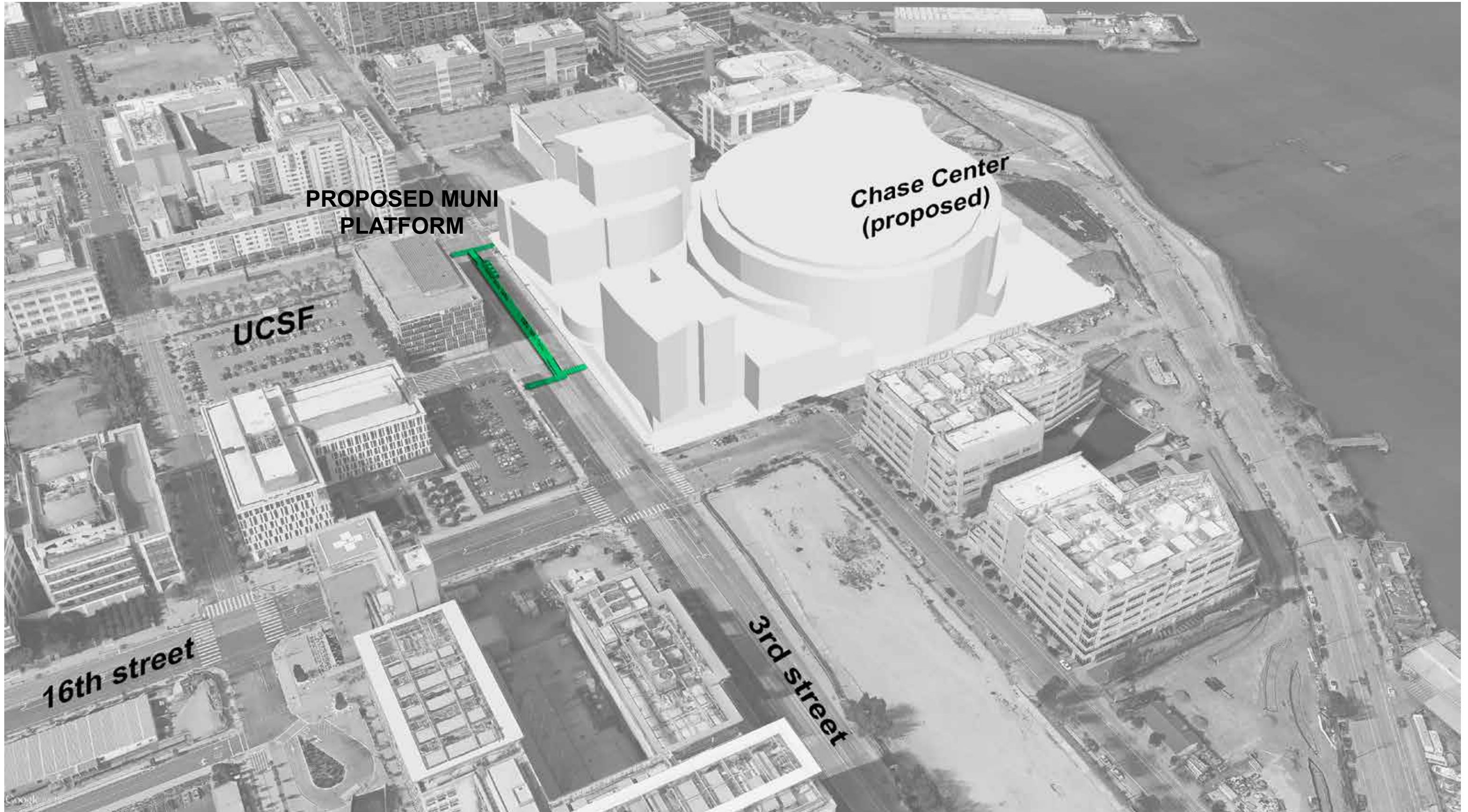

ELEVATIONS

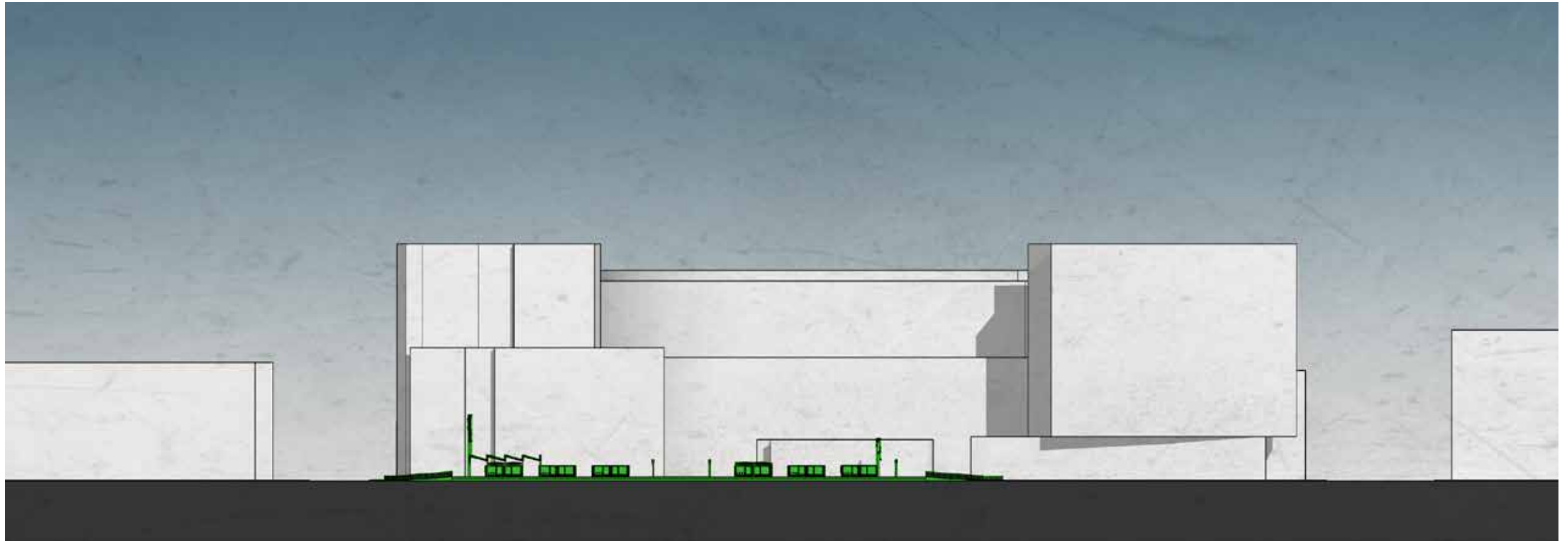

ELEVATION - EAST

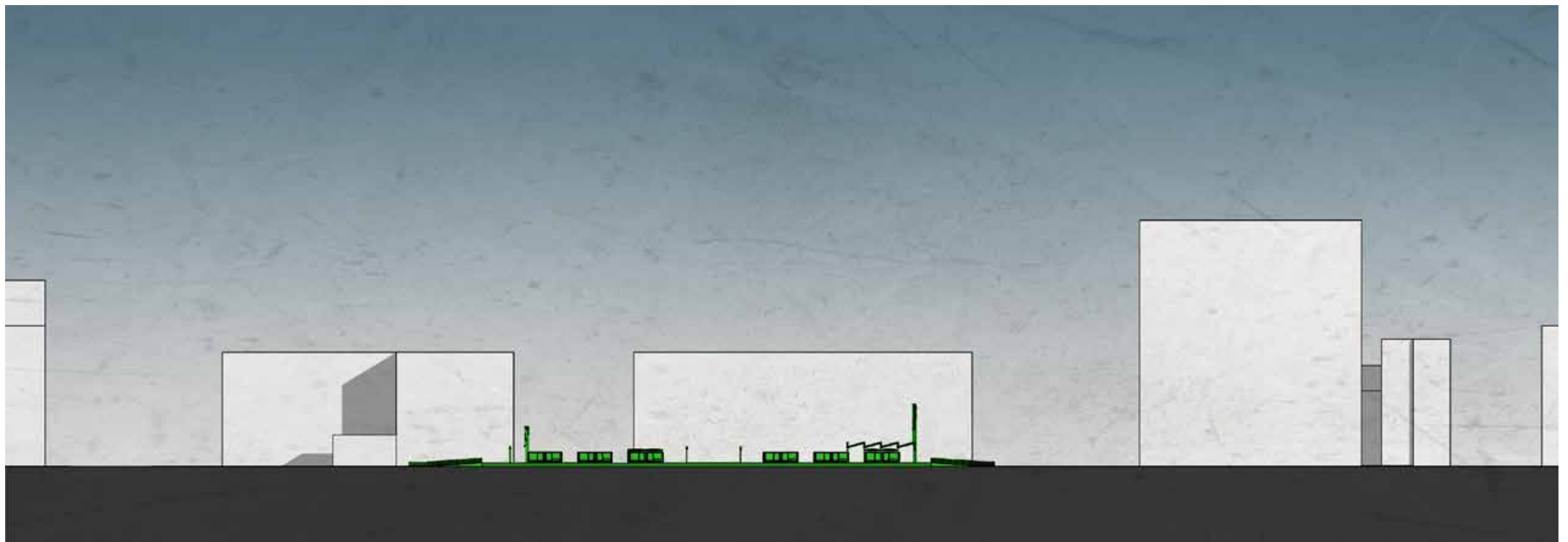

ELEVATION - WEST

PERSPECTIVE VIEWS



PERSPECTIVE VIEW - SOUTH



PERSPECTIVE VIEW - NORTH

PERSPECTIVE VIEW

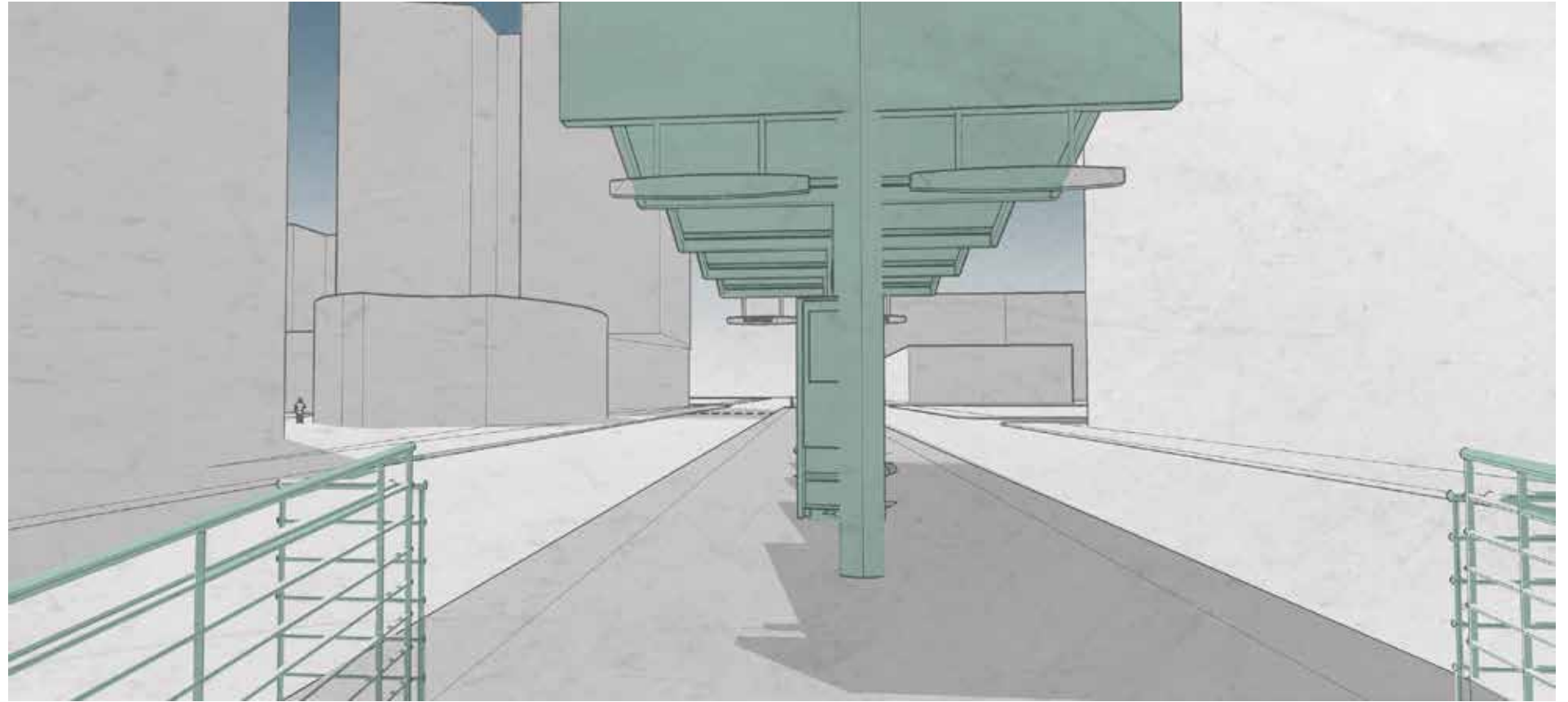

PERSPECTIVE VIEW - SOUTH

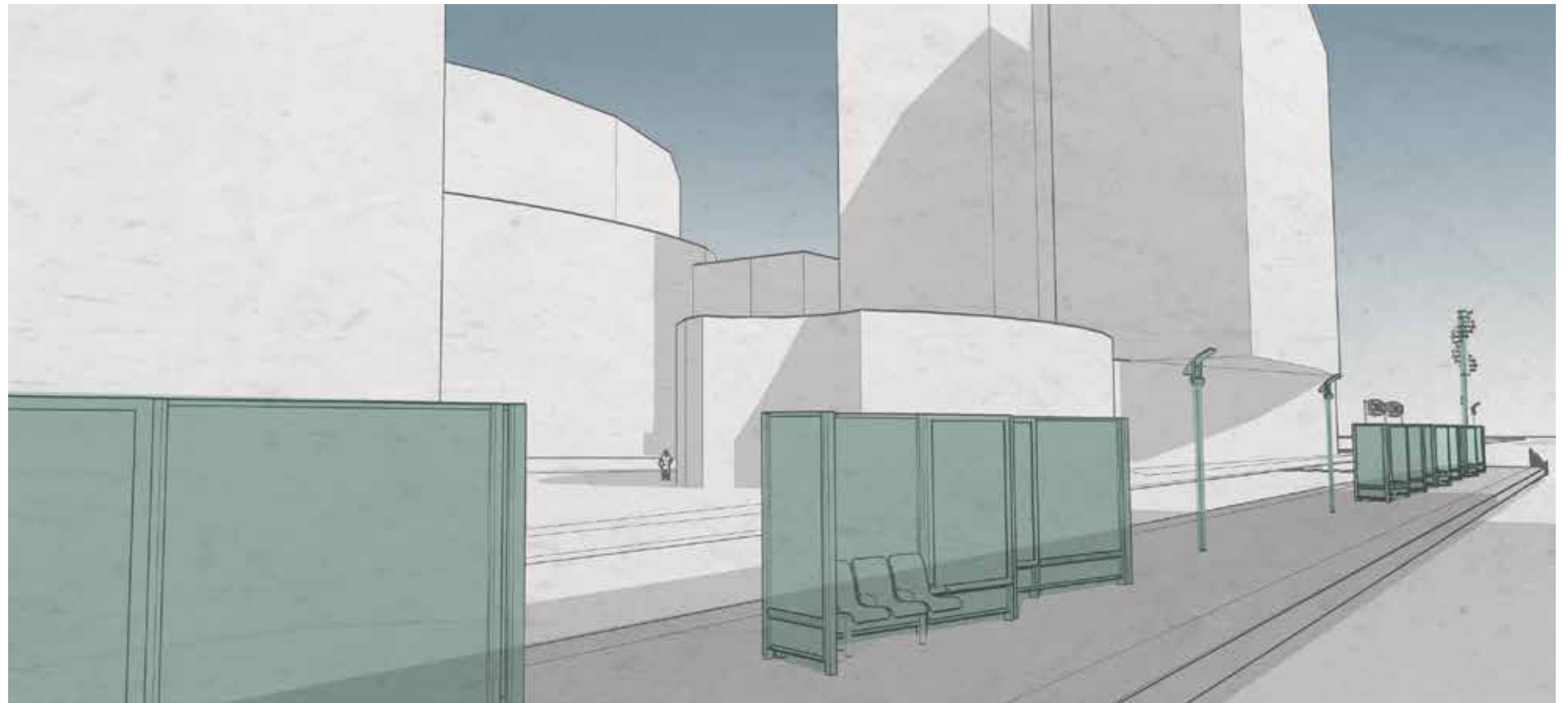

PERSPECTIVE VIEW - EAST

EXISTING PUBLIC ART TO BE RETAINED



METAL SHADOWCASTERS ON CANOPY



EMBEDDED METAL LETTERS ON PLATFORM

