

Documents submitted by the Determination Holder for the hearing
on February 10, 2021.

Written Summary of Requirements for Stair Relocation 482 16th Avenue

Below is a brief description and image of the existing condition, for context.

The rear deck is 12' wide. The stairs are 3'3" wide and located along its north end which borders the property line. They extend down 8'10" before turning 90-degrees south and extending another 6'6" to grade. This rise and run, plus an L shaped turn, minimizes encroachment into the shallow rear yard.

To the immediate south of the existing stair is a mature Japanese Maple tree. Just south of that is a set of poured concrete stairs that lead to a below-grade patio and foundation leading to a door on the basement floor.



The scope of work required to re-locate the stair and fire wall from the property line would depend on how far south it is moved and the final design of replacement features. Since the deck is only 12' wide, the maximum shift would put the north edge of the stair rail about 8' from the property line.

To accomplish that, the following actions would be required:

- Professional re-design of the stair, deck, and other rear yard features (retention of architect/landscape architect/general contractor).
- Submittal and processing of associated building permits.
- Potential processing of additional Variances to accommodate any associated rear yard encroachments from the new stair.
- Physical demolition and reconstruction of portions of the rear brick patio at grade level and below grade concrete planter/patio/foundation to construct a new concrete stair providing egress from the building's first floor.
- Redesign and of firewall and fence at property line accommodating basement stairs.
- Repurchase, removal and relocation of railing system and stair railings.

- Removal and relocation of natural gas, high voltage electrical and irrigation lines below-grade.
- Potential removal of the mature Japanese Maple tree.

Below is a chart representing an expected set of core activities required to design and complete relocation of the existing fire and stair well, including associated modifications to the other building and rear yard features necessitated by the move. The activities and associated timing expectations are necessarily preliminary and intended to provide a general summary of the scope of required work. Some of these tasks could be done in parallel (e.g. demolition and sourcing) while others would be sequential (ex: design planning, building permitting, physical construction).

Following the Board's 1/27/21 hearing, we reached out to a developer and general contractor to discuss this scope and were provided a general "best" estimate of 12 weeks and a conservative estimate of 24 weeks to complete the work.

Regarding costs it is hard to provide a detailed estimate without a specific design. However, our contacts have stated that the stair and firewall relocation project, start to finish, could cost "six figures."

Anticipated Task Schedule

	Task Item	Time		Task Item	Time	
Design	Landscape Architect	3w		Demolition firewall	INC	
	General Contractor	2w		Demolition stair and stringers	INC	
	Engineer	3w		Remove railing	INC	
Permitting	Variance (if required)	10w	Construction	Materials On-Site	2w	
	Building Permit Submittal and Approval	1-20w		R&R foundation, footings, and tub wall	1w	
	311 Notice	5w		R&R lower stairs	2w	
	Appeals (if filed)	4-6w		R&R lower drains	INC	
	Street permits	1w		R&R deck truss	INC	
	Demolition Permit	1w		Stair headers	1w	
Pre-Construction	Geotechnical analysis	3w		Fabricate stringers and treads	1w	
	Site preparation	2w		Landscape repair, pavers and pour	2w	
Sourcing	Electrical Contractor	1w		Relocate gas drop and grill	2w	
	Framing Contractor	2w		Relocate high and low voltage electrical drops	1w	
	Railing system design and quotes	2w		Replace siding and fascia	1w	
	Lumber and materials quote	1w		Paint and stain	2w	
	Concrete Contractor	1w		Install railing system and stair rails	2w	
	Gas Plumbing Contractor	1w		R&R Irrigation	1w	
Demolition	Demolition Contractor	1w		R&R paver and pads	1w	
	Demolition and prep	2w	Inspections	Inspections and final signoff	2-10w	
	Debris removal	1w				
	Site staging	1w				

Corrected Plans (Dated: 6-6-19 and revised 1-30-21)

Revised plans which accurately reflect the location of the rear yard setback line and dimension, correct the dimension and location of the Appellants' rear bathroom window adjacent to the firewall and stair, and confirm accuracy of the stair measurements.

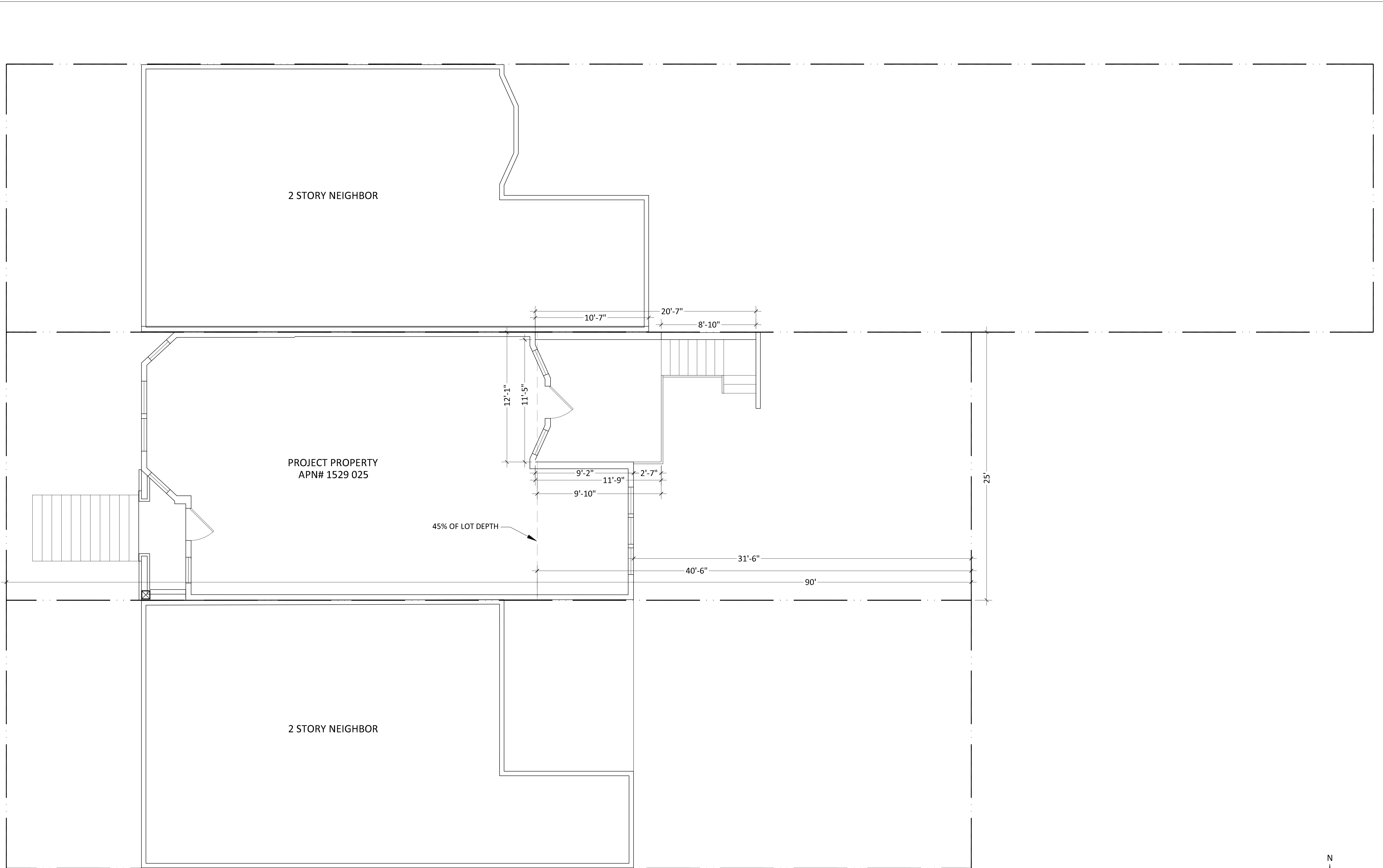

SITE PLAN

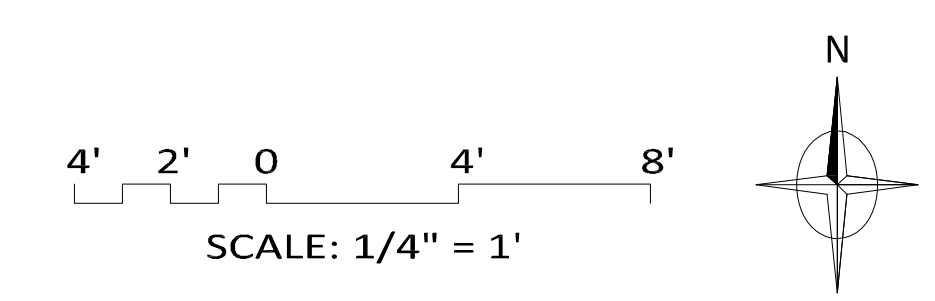

PLANS PREPARED BY:
 GREG WEHRS
 2115 SHATTUCK AVENUE
 BERKELEY, CA 94702
 510-775-2117

PLANS PREPARED FOR:
 MARK SOLE
 482 16TH AVENUE
 SAN FRANCISCO, CA

SHEET TITLE:
 SITE PLAN

PROJECT ADDRESS:
 482 16TH AVE.
 SAN FRANCISCO, CA

DATE 6-6-19
 REVISIONS 1-30-21

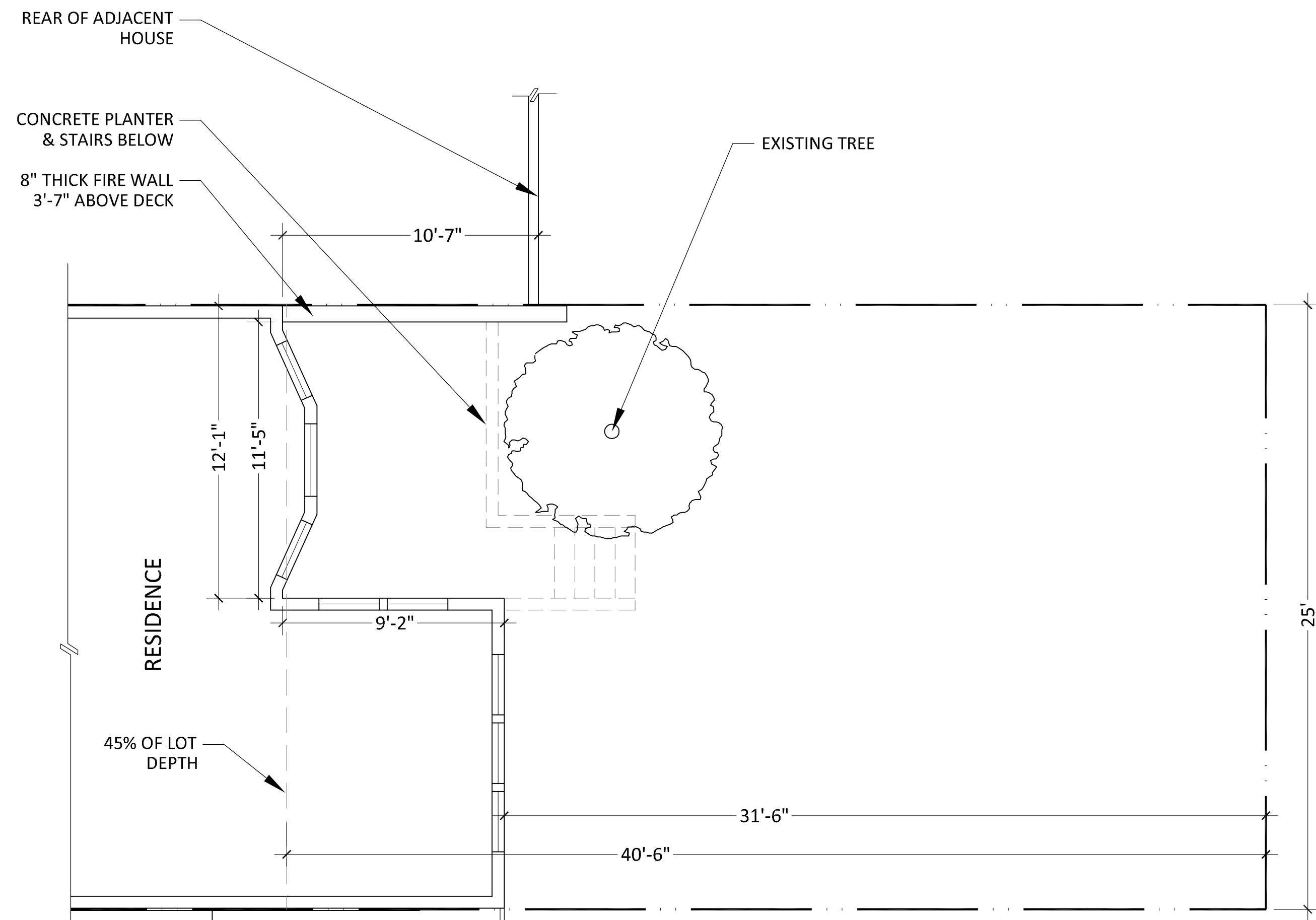

PRE DECK- PLAN VIEW

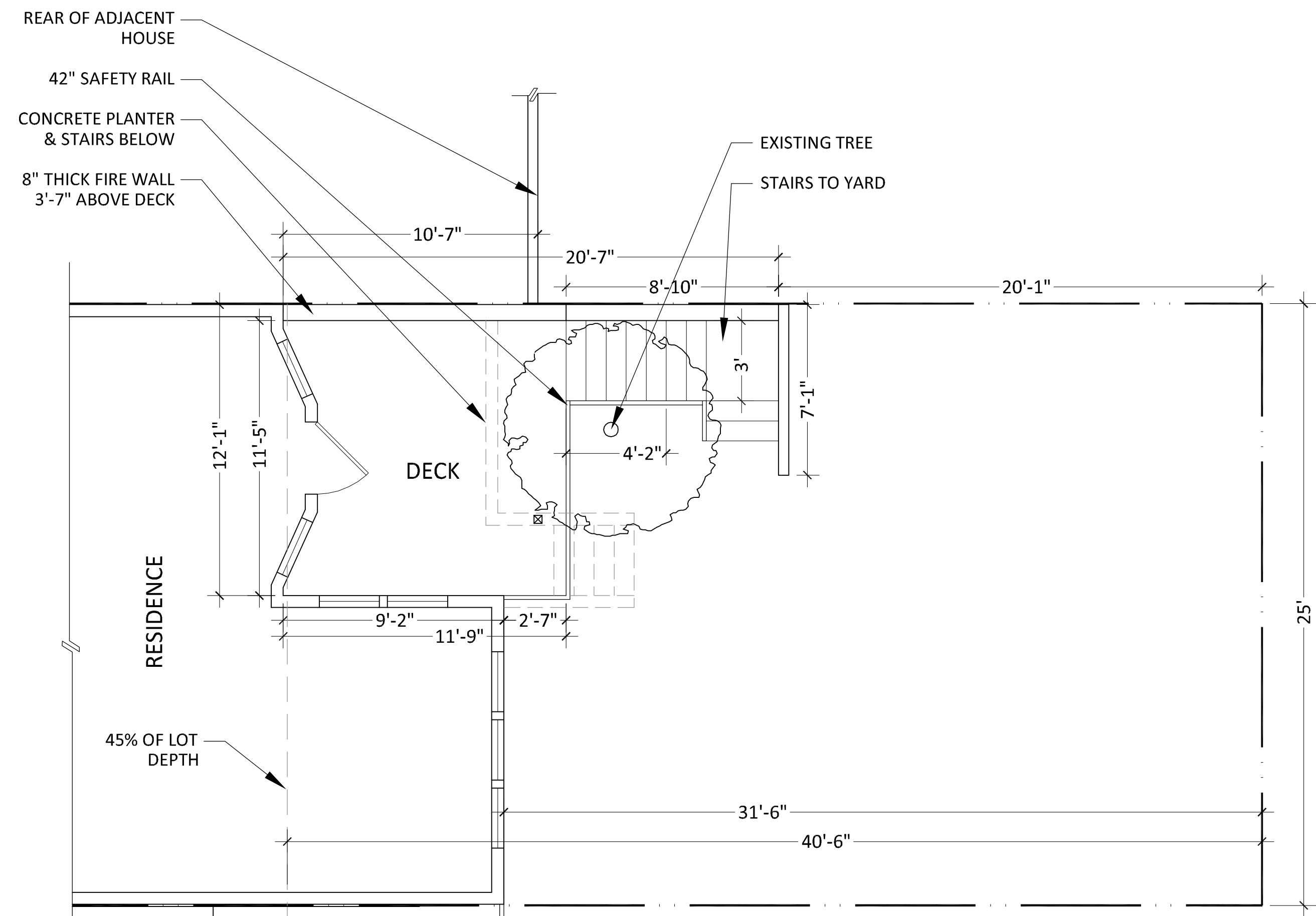

EXISTING- PLAN VIEW

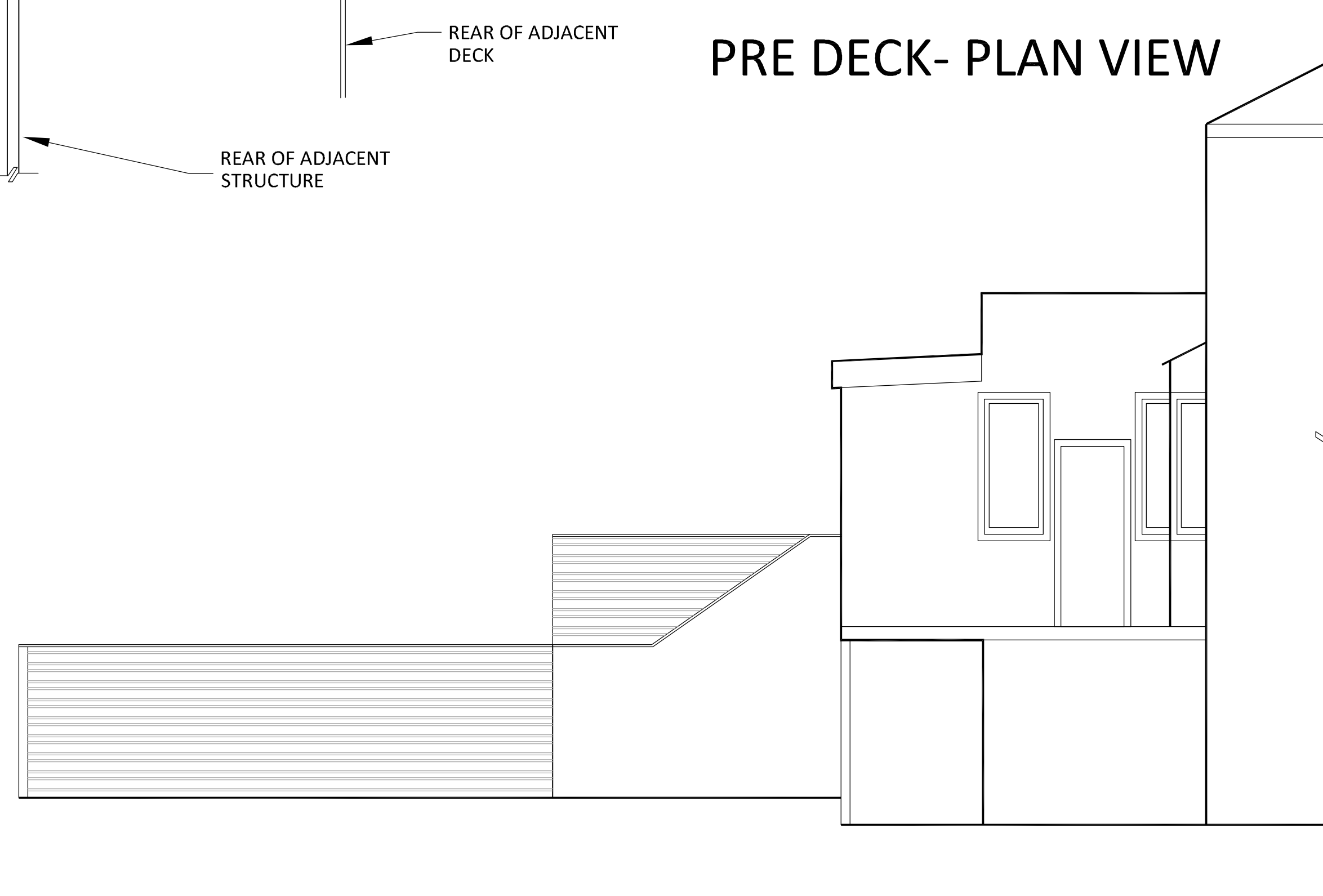

ELEVATION SOUTH TOWARDS SUBJECT PROPERTY FROM 478 16TH AVE.

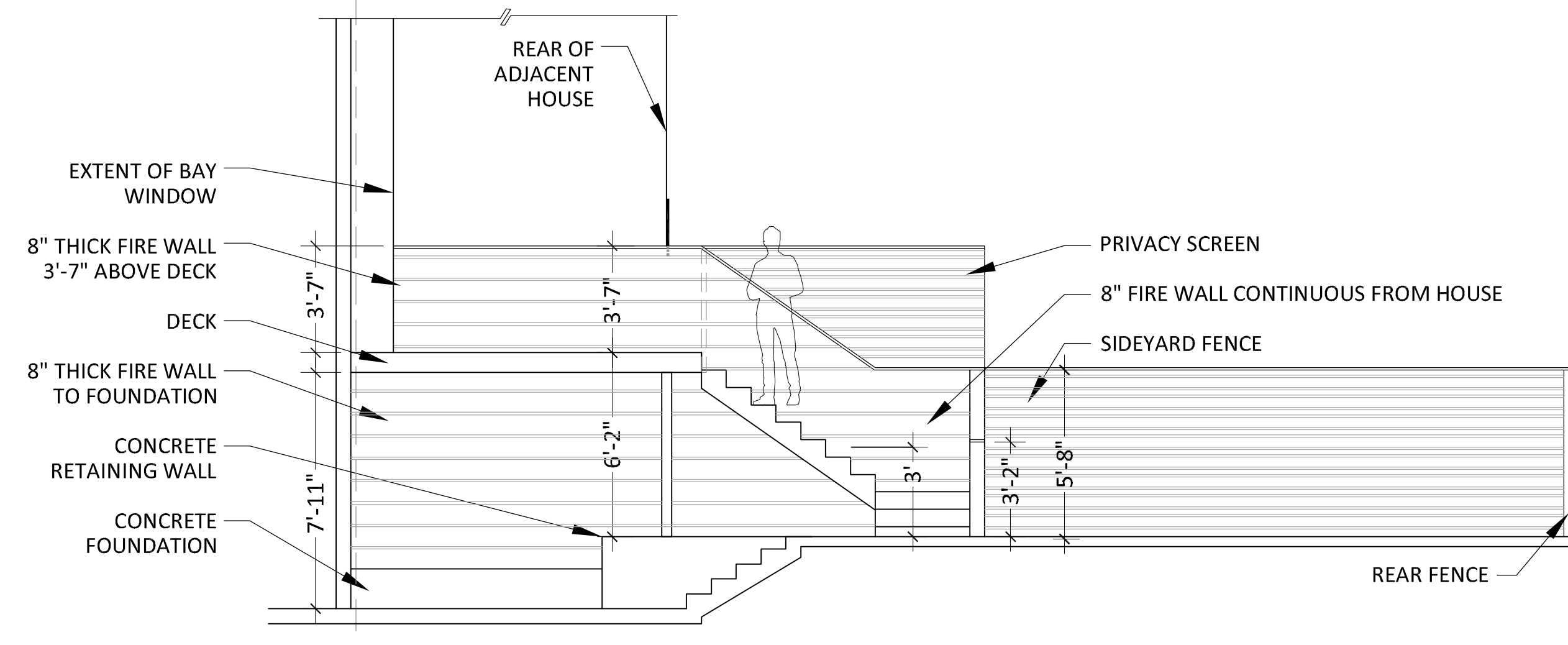
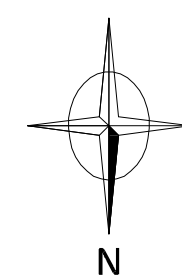

ELEVATION NORTH FROM SUBJECT PROPERTY TOWARDS 478 16TH AVE.

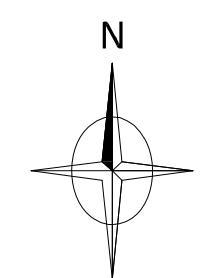

4' 2' 0 4' 8'
SCALE: 1/4" = 1'

PLANS PREPARED BY:
GREG WEHRS
2115 SHATTUCK AVENUE
BERKELEY, CA 94702
510-775-2117

PLANS PREPARED FOR:
MARK SOLE
482 16TH AVENUE
SAN FRANCISCO, CA

SHEET TITLE:
PLAN & ELEVATION

PROJECT ADDRESS:
482 16TH AVE.
SAN FRANCISCO, CA

DATE: 6-6-19
REVISIONS: 1-30-21



PRE DECK- REAR ELEVATIONS



EXISTING- REAR ELEVATIONS

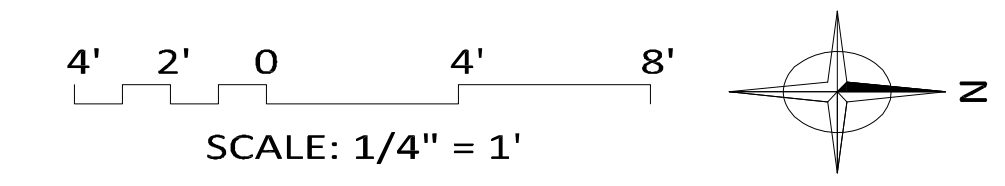

PLANS PREPARED BY:
 GREG WEHRS
 2115 SHATTUCK AVENUE
 BERKELEY, CA 94702
 510-775-2117

PLANS PREPARED FOR:
 MARK SOLE
 482 16TH AVENUE
 SAN FRANCISCO, CA

SHEET TITLE:
 REAR ELEVATIONS

PROJECT ADDRESS:
 482 16TH AVE.
 SAN FRANCISCO, CA

DATE 6-6-19
 REVISIONS 1-30-21

Corrected Plans with Proposed One Foot Riser (Dated: 6-6-19 and revised 1-30-21)

Revised plan set with corrected measurements and a proposed elevation illustrating the addition of a 1' riser screen above the existing firewall.

2 STORY NEIGHBOR

PROJECT PROPERTY
APN# 1529 025

2 STORY NEIGHBOR

45% OF LOT DEPTH

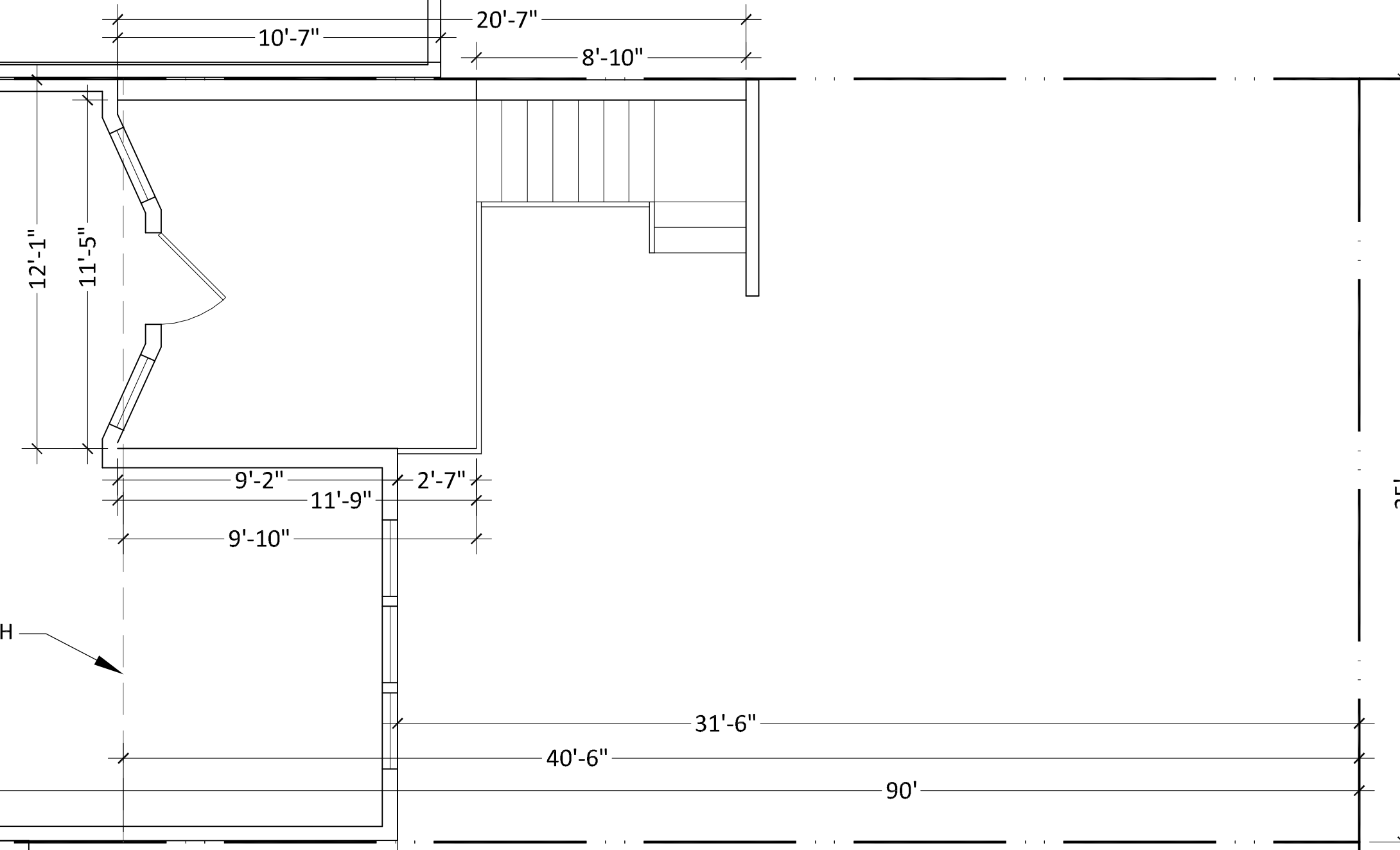

SITE PLAN

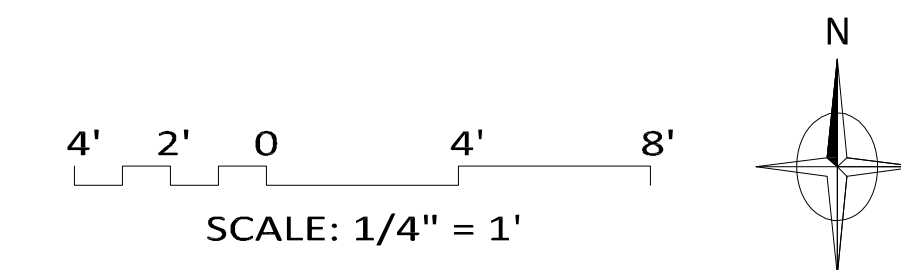

PLANS PREPARED BY:
 GREG WEHRS
 2115 SHATTUCK AVENUE
 BERKELEY, CA 94702
 510-775-2117

PLANS PREPARED FOR:
 MARK SOLE
 482 16TH AVENUE
 SAN FRANCISCO, CA

SHEET TITLE:
 SITE PLAN

PROJECT ADDRESS:
 482 16TH AVE.
 SAN FRANCISCO, CA

DATE 6-6-19
 REVISIONS 1-30-21

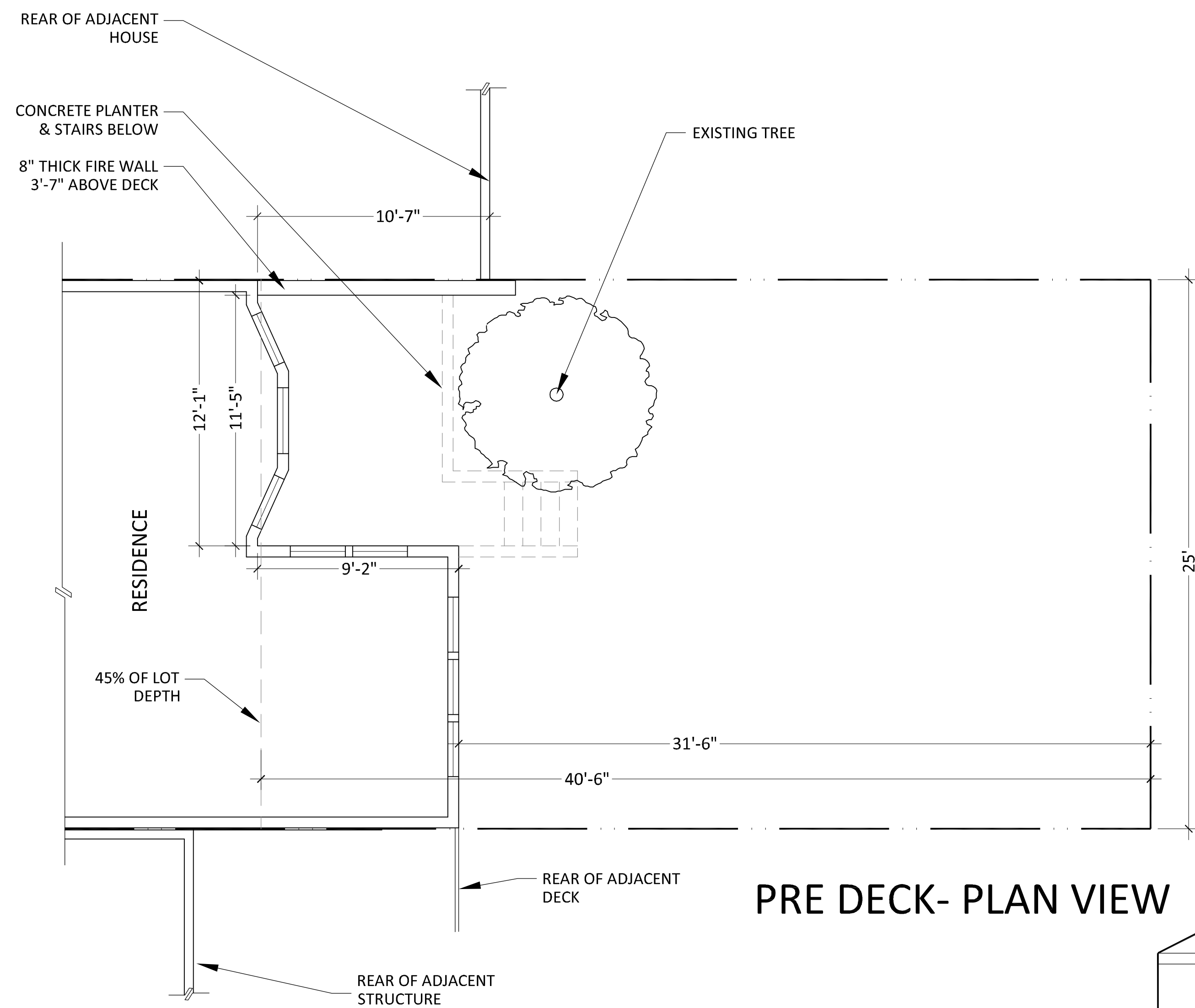

PRE DECK- PLAN VIEW

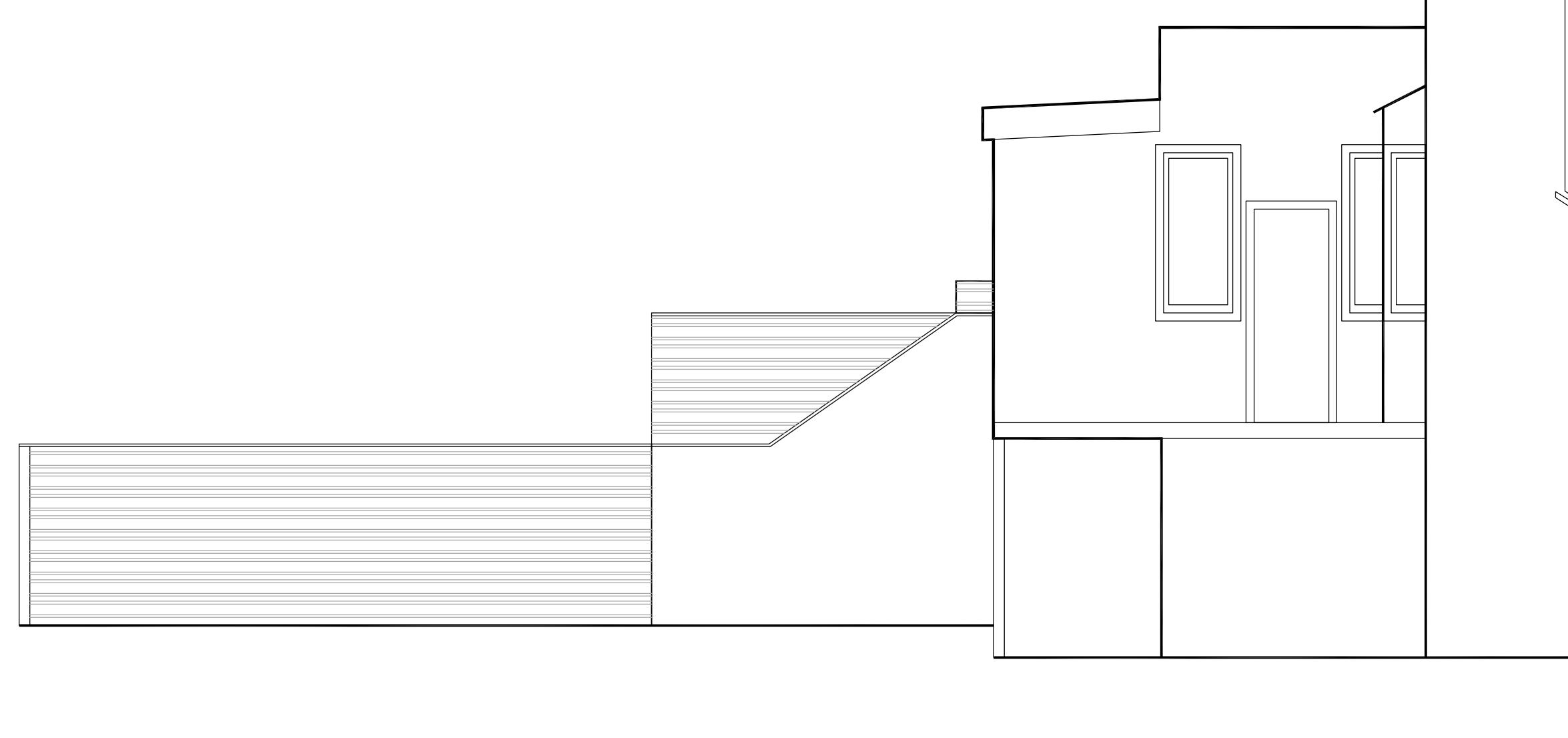

ELEVATION SOUTH TOWARDS SUBJECT PROPERTY FROM 478 16TH AVE.

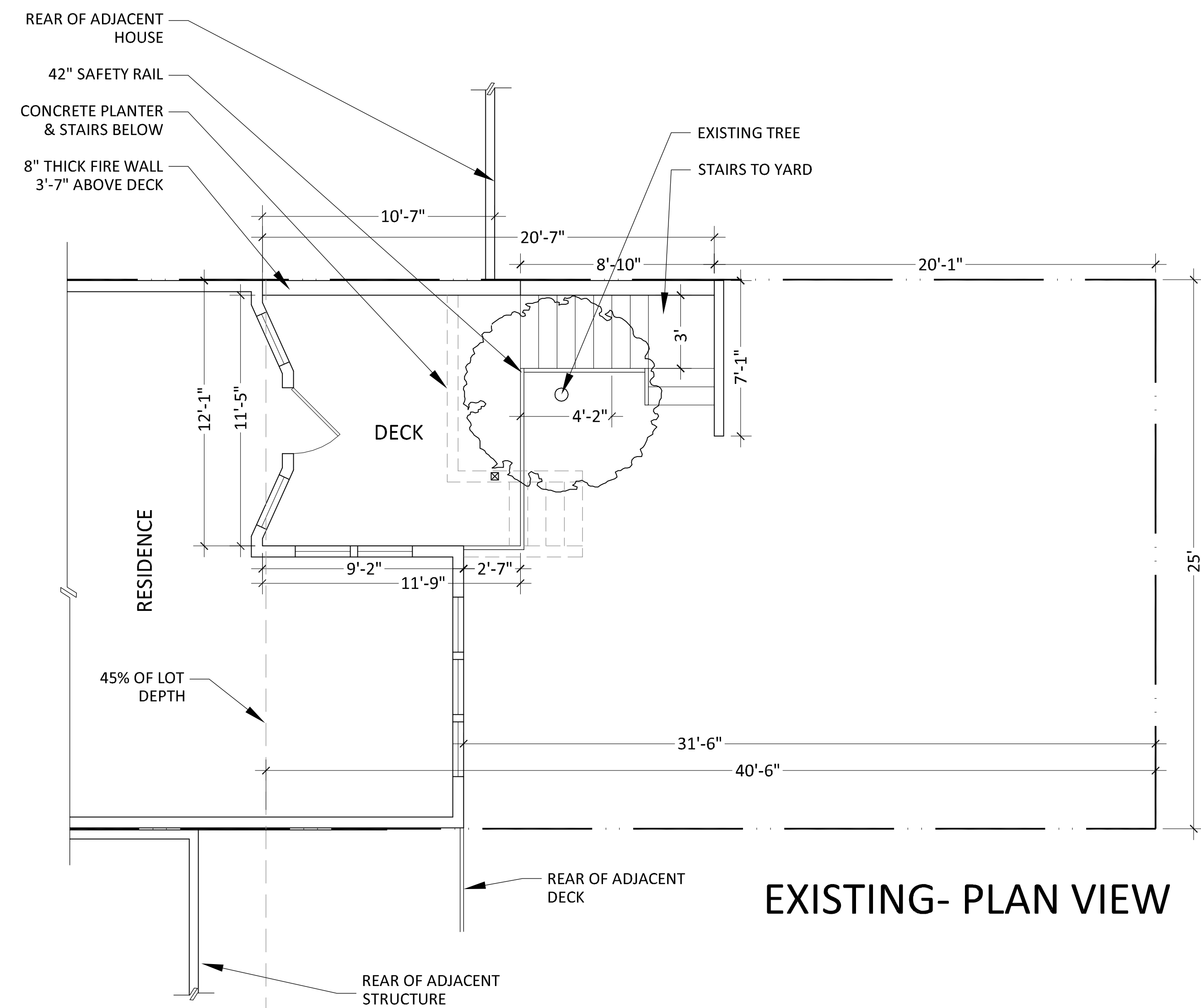
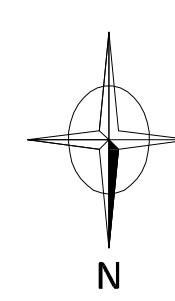

EXISTING- PLAN VIEW

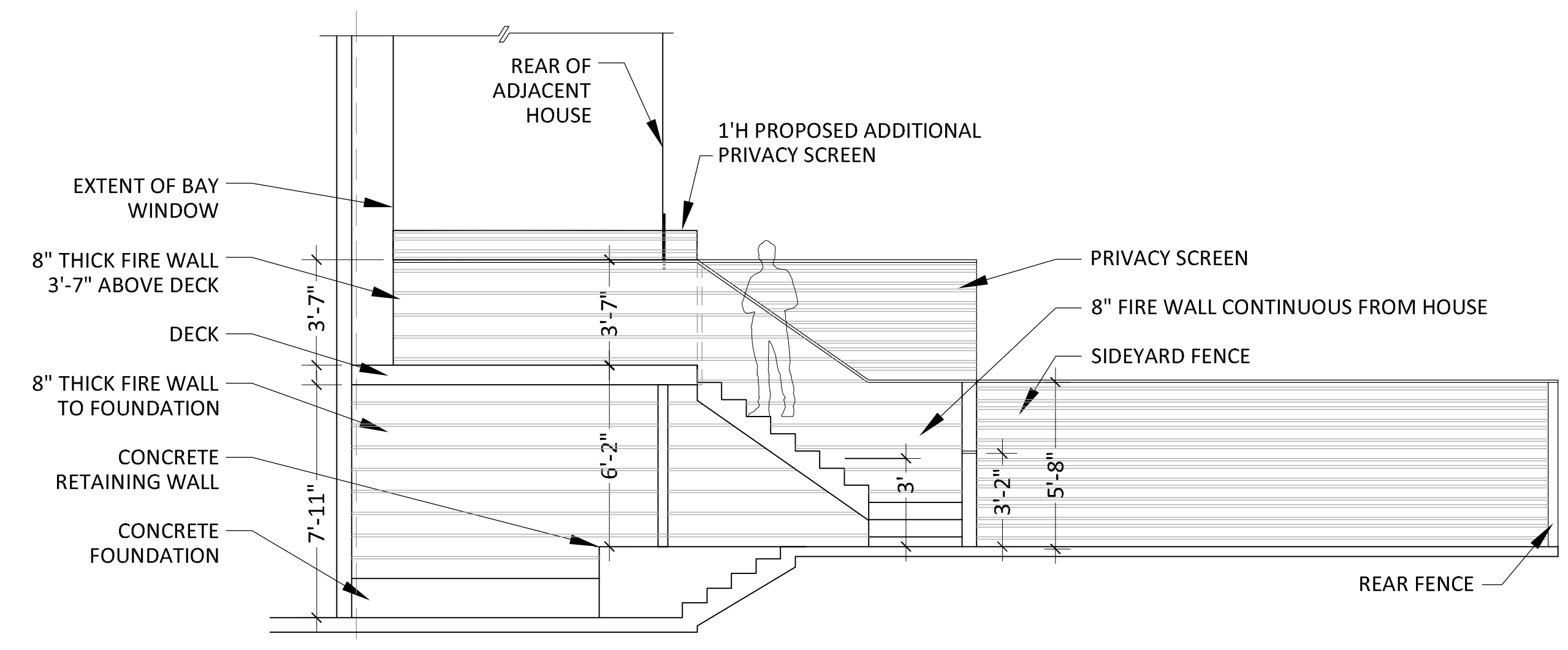

ELEVATION NORTH FROM SUBJECT PROPERTY TOWARDS 478 16TH AVE.

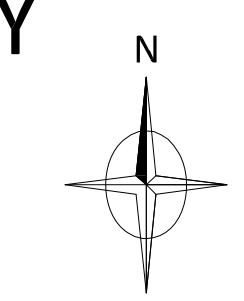
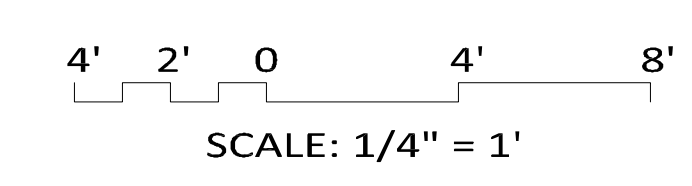

PLANS PREPARED BY:
GREG WEHRS
2115 SHATTUCK AVENUE
BERKELEY, CA 94702
510-775-2117

PLANS PREPARED FOR:
MARK SOLE
482 16TH AVENUE
SAN FRANCISCO, CA

SHEET TITLE:
PLAN & ELEVATION

PROJECT ADDRESS:
482 16TH AVE.
SAN FRANCISCO, CA

DATE 6-6-19

REVISIONS 1-30-21



PRE DECK- REAR ELEVATIONS



EXISTING- REAR ELEVATIONS

PLANS PREPARED BY:

GREG WEHRS
2115 SHATTUCK AVENUE
BERKELEY, CA 94702
510-775-2117

PLANS PREPARED FOR:

MARK SOLE
482 16TH AVENUE
SAN FRANCISCO, CA

SHEET TITLE:

REAR ELEVATIONS

PROJECT ADDRESS:

482 16TH AVE.
SAN FRANCISCO, CA

DATE 6-6-19

REVISIONS 1-30-21

DOCUMENTS SUBMITTED FOR THE ORIGINAL HEARING ON JANUARY 27, 2021

BOARD OF APPEALS, CITY & COUNTY OF SAN FRANCISCO

Appeal of
EDMUND LOUIE and MARY CONSTANCE PARKS,)
Appellant(s))
vs.)
ZONING ADMINISTRATOR,)
Respondent)

Appeal No. **20-087**

NOTICE OF APPEAL

NOTICE IS HEREBY GIVEN THAT on December 17, 2020, the above named appellant(s) filed an appeal with the Board of Appeals of the City and County of San Francisco from the decision or order of the above named department(s), commission, or officer.

The substance or effect of the decision or order appealed from is the ISSUANCE on December 9, 2020 to Mark Sole, of a Variance (the proposal is to legalize the construction of a rear deck and stairs; the demolition of the previously existing deck was approved by the Planning Dept. in May 2012, however, the deck was reconstructed to be larger than previously existed and the stairs were shifted from the middle of the lot to the northern property line; therefore both the deck and stairs require legalization; the subject property has a required rear yard of approximately 39 feet and the deck and stairs proposed for legalization are entirely located within the required rear yard; the Zoning Administrator granted the rear yard variance) at 482 16th Avenue.

APPLICATION NO. 2019-005619VAR

FOR HEARING ON January 27, 2021

Address of Appellant(s):

Address of Other Parties:

Edmund Louie and Mary Constance Parks, Appellant(s) 478 16th Avenue San Francisco, CA 94118	Mark Sole, Determination Holder(s) 482 16th Avenue San Francisco, CA 94118
---	--



Date Filed: December 17, 2020

**CITY & COUNTY OF SAN FRANCISCO
BOARD OF APPEALS**

PRELIMINARY STATEMENT FOR APPEAL NO. 20-087

I / We, **Edmund Louie and Mary Constance Parks**, hereby appeal the following departmental action: **ISSUANCE** of **Variance Case No. 2019-005619VAR** by the **Zoning Administrator** which was issued or became effective on: **December 9, 2020**, to: **Mark Sole**, for the property located at: **482 16th Avenue**.

BRIEFING SCHEDULE:

The Appellants may, but are not required to, submit a one page (double-spaced) supplementary statement with this Preliminary Statement of Appeal. No exhibits or other submissions are allowed at this time.

Appellants' Brief is due on or before: 4:30 p.m. on **January 7, 2021**, (**no later than three Thursdays prior to the hearing date**). The brief may be up to 12 pages in length with unlimited exhibits. It shall be double-spaced with a minimum 12-point font. An electronic copy should be emailed to: boardofappeals@sfgov.org, julie.rosenberg@sfgov.org, scott.sanchez@sfgov.org and marknssole@gmail.com.

Respondent's and Other Parties' Briefs are due on or before: 4:30 p.m. on **January 21, 2021**, (**no later than one Thursday prior to hearing date**). The brief may be up to 12 pages in length with unlimited exhibits. It shall be double-spaced with a minimum 12-point font. An electronic copy should be emailed to: boardofappeals@sfgov.org, julie.rosenberg@sfgov.org, scott.sanchez@sfgov.org and edmund@edmundlouie.com.

The Board's physical office is closed to the public and hard copies of the brief do NOT need to be submitted.

Only photographs and drawings may be submitted by the parties at the hearing.

Hearing Date: **Wednesday, January 27, 2021, 5:00 p.m.**, via Zoom. Information for access to the hearing will be provided before the hearing date.

All parties to this appeal must adhere to the briefing schedule above, however if the hearing date is changed, the briefing schedule MAY also be changed. Written notice will be provided of any change to the briefing schedule.

In order to have their documents sent to the Board members prior to hearing, **members of the public** should email all documents of support/opposition no later than one Thursday prior to hearing date by 4:30 p.m. to boardofappeals@sfgov.org. Please note that names and contact information included in submittals from members of the public will become part of the public record. Submittals from members of the public may be made anonymously.

Please note that in addition to the parties' briefs, any materials that the Board receives relevant to this appeal, including letters of support/opposition from members of the public, are distributed to Board members prior to hearing. All such materials are available for inspection on the Board's website at www.sfgov.org/boa. You may also request a copy of the packet of materials that are provided to Board members at a cost of 10 cents per page, per S.F. Admin. Code Ch. 67.28.

The reasons for this appeal are as follows:

No statement submitted.

Appellant or Agent (Circle One):

Signature: Edmund Louie via Email

Print Name: Edmund Louie



VARIANCE DECISION

Date: December 9, 2020
Case No.: 2019-005619VAR
Project Address: 482 16TH AVENUE
Block/Lots: 1529 / 025
Zoning: RH-2 (Residential, House – Two-Family)
Height/Bulk: 40-X Height and Bulk District
Applicant/Owner: Mark Sole
482 16th Avenue
San Francisco, CA 94118
Staff Contact: Matt Dito – (628) 652-7358
Matthew.Dito@sfgov.org

Description of Variance – Rear Yard Variance Sought:

The proposal is to legalize the construction of a rear deck and stairs. The demolition and reconstruction of the previously existing deck was approved by the Planning Department in May 2012. However, the deck was reconstructed to be larger than what previously existed, and the stairs were shifted from the middle of the lot to the northern property line. Therefore, both the deck and stairs require legalization

Planning Code Section 134 requires properties in the RH-2 Zoning District to maintain a rear yard equivalent to 45 percent of the total lot depth at grade level and at each succeeding story of the building, unless reduced to the average of qualifying adjacent rear building walls. The subject property, with a lot depth of approximately 90 feet has a required rear yard of approximately 39 feet. The deck and stairs proposed for legalization are entirely located within the required rear yard. Therefore, a rear yard variance is required.

Procedural Background:

1. The Project is exempt from the California Environmental Quality Act (“CEQA”) as a Class 1 categorical exemption.
2. The Zoning Administrator held a public hearing on **Variance Application No. 2019-005619VAR** on **October 28, 2020**.
3. Planning Code Section 311 notification is required and will be conducted prior to the building permit for this project being approved.

Decision:

GRANTED, in general conformity with the plans on file with this application, shown as EXHIBIT A, to legalize the construction of a previously built deck and stairs in the required rear yard, subject to the following conditions:

1. The authorization and rights vested by virtue of this decision letter **shall be deemed void and cancelled** if (1) a Site or Building Permit has not been issued within three years from the effective date of this decision; or (2) a Tentative Map has not been approved within three years from the effective date of this decision for Subdivision cases; or (3) neither a Site or Building Permit or Tentative Map is involved but another required City action has not been approved within three years from the effective date of this decision. However, this authorization may be extended by the Zoning Administrator when implementation of the project is delayed by a public agency, an appeal or a legal challenge and only by the length of time for which such public agency, appeal or challenge has caused delay.
2. Any future physical expansion, even in the buildable area, shall be reviewed by the Zoning Administrator to determine if the expansion is compatible with existing neighborhood character and scale. If the Zoning Administrator determines that there would be a significant or extraordinary impact, the Zoning Administrator shall require either notice to adjacent and/or affected property owners or a new Variance application be sought and justified.
3. The proposed project must meet these conditions and all applicable City Codes. In case of conflict, the more restrictive controls apply.
4. Minor modifications as determined by the Zoning Administrator may be permitted.
5. The owner of the subject property shall record on the land records of the City and County of San Francisco the conditions attached to this Variance decision as a Notice of Special Restrictions in a form approved by the Zoning Administrator.
6. This Variance Decision and the recorded Notice of Special Restrictions shall be reproduced on the Index Sheet of the construction plans submitted with the Site or Building Permit Application for the Project, if applicable.

Findings:

Section 305(c) of the Planning Code states that in order to grant a variance, the Zoning Administrator must determine that the facts of the case are sufficient to establish the following five findings:

FINDING 1.

That there are exceptional or extraordinary circumstances applying to the property involved or to the intended use of the property that do not apply generally to other properties or uses in the same class of district.

Requirement Met.

- A. The subject single-family structure was built circa 1911, has an approximately 10-foot front setback, and has an original portion of the building on the south side that extends into the required rear yard. With a lot depth of 90 feet, the lot is smaller than what is typical in the neighborhood, as the immediately adjacent property to the north has a lot depth of approximately 128 feet. These lot conditions result in less buildable area on the subject property than what is typical for the neighborhood.

- B. The single-family dwelling maintains two access points to the rear yard, which is the only source of required usable open space on the lot. While the deck and stairs provide direct access from the common living area, the secondary access to the rear yard requires using an internal stairway at the front of the home, descending into the garage, and traversing nearly the entire length of the building. While the deck and stairs are not required for rear yard access, the alternative route is not a convenient means of access.

FINDING 2.

That owing to such exceptional and extraordinary circumstances the literal enforcement of specified provisions of this Code would result in a practical difficulty or unnecessary hardship not created by or attributed to the applicant or the owner of the property.

Requirement Met.

- A. Literal enforcement of the Planning Code would represent a practical difficulty toward maintaining a modest deck and stairs at the rear to provide a small amount of useable open space and direct access to the rear yard, which is a common feature within RH-2 Zoning Districts and single-family dwellings, including on the subject block.

FINDING 3.

That such variance is necessary for preservation and enjoyment of a substantial property right of the subject property, possessed by other property in the same class of district.

Requirement Met.

- A. Granting this variance will allow the subject property to preserve and enjoy convenient access to required useable open space for the dwelling unit in a manner that is modest in nature, is consistent with the subject block, and has existed at the subject property for a significant period of time. This represents a substantial property right of the subject property and is generally possessed by other properties in the same class of district.

FINDING 4.

That the granting of such variance will not be materially detrimental to the public welfare or materially injurious to the property or improvements in the vicinity.

Requirement Met.

- A. Granting the variance will improve the livability of the subject property and will not be materially detrimental to the public welfare or materially injurious to the neighboring properties. The deck is less than 10 feet tall from grade, falls within the area where a 12-foot “pop-out” could be permitted if the existing building was Code-conforming, falls within an indentation in between the building projections on the subject lot and the adjacent lot to the north, and is mostly screened by a Code-complying fence along the northern property line.
- B. The Planning Department determined the project to be consistent with the Residential Design Guidelines. The Department received one letter of opposition to the proposed project from the owner of

the property immediately adjacent to the north, who believes the property line stairs descending from the deck are detrimental to their property. A letter of support from a neighbor was also received, citing the proposal as being a common feature in the neighborhood.

FINDING 5.

The granting of such variance will be in harmony with the general purpose and intent of this Code and will not adversely affect the General Plan.

Requirement Met.

- A. This development is consistent with the generally stated intent and purpose of the Planning Code to promote orderly and beneficial development. Planning Code Section 101.1 establishes eight priority-planning policies and requires review of variance applications for consistency with said policies. The project meets all relevant policies, including conserving neighborhood character, and maintaining housing stock.
1. Existing neighborhood retail uses will not be adversely affected by the proposed project.
 2. The proposed project will be in keeping with the existing housing and neighborhood character. The proposal will preserve the existing dwelling unit on the property.
 3. The proposed project will have no effect on the City's supply of affordable housing.
 4. The proposed project does not adversely affect neighborhood parking or public transit.
 5. The project will have no effect on the City's industrial and service sectors.
 6. The proposed project will have no effect on the City's preparedness to protect against injury and loss of life in an earthquake.
 7. The project will have no effect on the City's landmarks or historic buildings.
 8. The project would not affect any existing or planned public parks or open spaces.

The effective date of this decision shall be either the date of this decision letter if not appealed, or the date of the Notice of Decision and Order if appealed to the Board of Appeals.

Once any portion of the granted variance is used, all specifications and conditions of the variance authorization become immediately operative.

Protest of Fee or Exaction: You may protest any fee or exaction subject to Government Code Section 66000 that is imposed as a condition of approval by following the procedures set forth in Government Code Section 66020. The protest must satisfy the requirements of Government Code Section 66020(a) and must be filed within 90 days of the date of the first approval or conditional approval of the development referencing the challenged fee or exaction. For purposes of Government Code Section 66020, the date of imposition of the fee shall be the date of the earliest discretionary approval by the City of the subject development.

If the City has not previously given Notice of an earlier discretionary approval of the project, the Planning Commission's adoption of this Motion, Resolution, Discretionary Review Action or the Zoning Administrator's Variance Decision Letter constitutes the approval or conditional approval of the development and the City hereby gives **NOTICE** that the 90-day protest period under Government Code Section 66020 has begun. If the City has already given Notice that the 90-day approval period has begun for the subject development, then this document does not re-commence the 90-day approval period.

APPEAL: Any aggrieved person may appeal this variance decision to the Board of Appeals within ten (10) days after the date of the issuance of this Variance Decision. For further information, please contact the Board of Appeals in person at 49 South Van Ness Ave, Suite 1475 (14th Floor), call 628-652-1150, or visit www.sfgov.org/bdappeal.

Very truly yours,



Corey A. Teague, AICP
Zoning Administrator

This is not a permit to commence any work or change occupancy. Permits from appropriate departments must be secured before work is started or occupancy is changed.

BRIEF(S) SUBMITTED BY APPELLANT(S)

Appellant Brief for 20-087

We the Appellants, Mary Parks and Edmund Louie, are the immediate neighbors to the north of Defendants Mark Sole and Adina Safer, who reside at the subject property. We respectfully ask the Board to revoke 2019-005619VAR and order the Defendants to move their illegal stairway/firewall away from our property line.

Background

We previously appealed the construction now under consideration before the Board on July 13, 2016 (Board of Appeals Case 16-0520), and timestamps in this brief refer to the video of that hearing published on the Board's meeting archive. Permit Application 201601046278 was under consideration that evening.

The discussion that night concluded when Mr. Sole accepted the Board's offer to negotiate a relocation of the deck and staircase with us rather than have the matter put to a vote by the Board [timestamp 4:01:15]. We left with some questions about some statements made at the hearing, but believing we would be negotiating *where* to move the staircase, not *if* it was to be moved.

We were to meet again with the Board in September 2016 to report back, but that agreement was ultimately derailed as we learned over the course of the next several weeks that the drawings under discussion that night (submitted with Permit Application 201601046278) were falsified by the Defendant. [Exhibit A]

We received a letter on August 8, 2016 from the Defendants' attorney, Melinda Sarjapur, rejecting any relocation of the staircase, which she based on a series of assertions we questioned. Ms. Sarjapur's letter also included a number of unserious proposals. [Exhibit B]

To answer Ms. Sarjapur's letter, we set about investigating her assertions as well as other troubling statements we heard made before the Board. We discovered that the drawings submitted by the Defendant with Permit Application 201635992 falsely represented the depth of the deck and size of the staircase, making it appear the construction conformed to code regarding the rear setback requirement, when in fact it did not.

Specifically, we discovered that: (1) The illegally built deck was substantially deeper--we estimate by 8.5 feet-- than the one depicted in the permit drawing and (2) the proportions of the deck and staircase were drawn to look as though they did not

extend as far into the rear setback as they actually did
[Exhibit C].

We had found ourselves feeling confused at the hearing whenever we heard someone assert that the construction did *not* violate code, as Messrs. Sole and Buscovich did repeatedly. Mr. Duffy stated several times that the illegal constructs were approvable based on his study of the plans. Aside from our knowing the construction greatly diminished our privacy and enjoyment of our backyard, our understanding from our Structural Engineer Eric Cox was that these structures violated the City's codes.

We also could not understand why Scott Sanchez of the Planning Department told the Board that the new deck was smaller than the one Mr. Sole demolished in 2012 [timestamp 3:54:45], when we knew it was in fact larger than the original deck.

We documented our findings with photos and drawings and sent them to Joseph Duffy of DBI and Scott Sanchez of the Planning Department, who represented their departments at our hearing. We also copied Cynthia Goldstein, this Board's Executive Director at the time. [Exhibit C]

We then sent a point-by-point response to Ms. Sarjapur as well as a copy of our report to Messrs. Duffy and Sanchez. We told Ms. Sarjapur we would consider *any* design which moved the staircase off the property line.[Exhibit D]

After reading our report, Mr. Duffy told us to file a complaint if we wished DBI to investigate the inaccuracies in Permit Application 201601046278. We filed Complaint 201635992 on September 9, resulting in our follow-up before the Board for September to be postponed so that DBI would have time to investigate.

Mr. Duffy made a site visit and issued a Notice of Violation in November 2016. That month we also received an Administrative Dismissal of our Appeal, where it was stated that the subject permit had been cancelled by DBI at the request of Mr. Sole. Later we learned that An Order of Abatement was subsequently issued to Mr. Sole in February 2019. [Exhibit E]

We cannot find words to express how we felt when we realized that we had all--the Board, Messrs. Duffy and Sanchez, and us--been misled by the drawings provided by Mr. Sole and his Structural Engineer, Pat Buscovich.

Application for variance

In February 2020, we were notified that the Defendants were seeking a variance which, if granted, would have the effect of legalizing the disputed construction covered by our Board of Appeals Case 16-0520.

In a pre-application meeting at the property, our architect asked for permission to verify the measurements in the drawings, to which the Defendants refused. On visual inspection of the drawings underlying this variance application, we see that the drawings are misleading. [Exhibit H]

The depictions of the south and north elevations on drawing shift their firewall/staircase/fence/deck assembly about 2 feet lower than they are in actuality, as can be seen from our ViewsSouthAndWest photos. The top of their fence does not align with the bottom of our house's extension and the firewall rises much higher in relation to our extension.

Depictions facing west also shift their firewall/staircase/fence/deck assembly about 2 feet lower than they are in actuality, as can be seen in this photo. The top of

their structure is in line with the south bathroom window on our extension, but their drawing depicts it at a much lower height.

In our presentation before the Zoning Administrator, we kept the focus on the 5 findings required by the Planning Department for issuance, as we were advised by staff that the Zoning Administrator was not able to consider the history of bad behavior. Nevertheless, in our letter of objection to the Zoning Administrator, we attached a copy of our report to Messrs. Duffy and Sanchez.

Other Reasons for Appeal

We are also asking the Board to revoke 2019-005619VAR because:

- 1) The firewall associated with the expanded deck and staircase on the property line is massive, unsightly, out of character for our residential block, and blocks light. It replaced a simple wooden fence with a tall and imposing wall.
- 2) It feels overwhelming and greatly diminishes the aesthetic appeal of looking out the rear windows and of being in the backyard, where open space and light is expected.
- 3) It deprives us of our privacy as the neighbors look down directly onto our yard as they ascend and descend along the property line.

4) The deck and rear staircase lie approximately 1.5 feet from one of our rear windows. The window is currently frosted, but there are times when we open the window and people are ascending and descending just 1.5 feet from our view. It is always alarming, and we have no privacy from that window when it is open.

5) Because the exterior rear staircase is right next to our home, the sound of people walking up and down the steps is loud and disturbing.

6) The side of the fence facing us that is on the firewall is not painted or treated in any way and is bare wood. The large firewall has no siding, and looks unfinished and unsightly. We have no idea how these materials will weather over time, as they appear untreated and exposed to the elements.

7) Further, the structural addition does not follow the Design Principles in the Planning Department's Residential Planning Guidelines. It extends around 127 inches past our building along our property line and stands at or near 10 feet above grade while all the other wooden fences in the area are 6 feet tall. It is out of scale with the surroundings, does not respect the mid-block open space, violates setback requirements, and is out of character for our neighborhood. The scale of the structure in relation to people can be seen in the attached HumanScaleBeforeAfter photos. [Exhibit G]

Conclusion

Our expectation all along has been that a Notice of Violation and then An Order of Abatement were sufficient mechanisms put in place by the City to enforce Planning and Building code requirements. The expectation that this neighbor would work with us in good faith was not followed by the Defendant.

This Board allowed the Defendants to escape a vote on their illegal construction in 2016 without knowing that the drawings and testimony it relied on from Mark Sole and Pat Buscovich were false. The Board only knew at the time that the large firewall and staircase were uncharacteristic for our neighborhood, built without permit, and that we had diminished privacy and enjoyment of our home and backyard. This Board did not know at the time that the deck was actually much larger than the drawing depicted it, and that the structure violated the rear setback requirements.

To this date we are not able to enjoy our privacy or our backyard, but we want to trust the processes put in place. We have trusted that at some point the City would make sure the neighbor rectified their non-compliant, unpermitted construction. We thought by now the structure would have been

moved away from the property line, replaced with a fence, and that there would be light and privacy restored to our home and backyard.

Of course we are frustrated and disappointed that this neighbor built this structure without going through the variance process in the first place. We were never given the right to voice our concerns before the City before they built this thing.

They built a structure without permit that violates code, and did so without seeking a variance. We suspect they did this knowingly to sidestep the City's planning and permitting processes and avoid a required Variance hearing:

- 1) They claim that this large construction was a "modification in the field" during the renovation work they were doing in 2012 under Permit 201205210880. However, they have never explained why they did not just follow the existing plans and rebuild the deck at its original size, and place the staircase in its original location.

- 2) They also claim they were trying to save a tree--but the original size and configuration of the staircase had no impact on the tree. They have never explained how the tree survived with the original configuration of the staircase, or how returning the staircase to its original configuration would endanger the tree.

3) They could have included the changed configuration of deck and staircase in their plans of April 2013 for Permit Application 201304083981, but did not take advantage of that opportunity to show the enlarged deck and relocated stairs.

4) When they finally responded to our Complaint 201525661, the drawings they submitted with Permit Application 201601046278 misrepresented the size of the structure and hid the code violation

5) They testified before the Board in 2016 that their structure was code compliant and permittable, when it was not, and they likely knew it was not. They had submitted falsified plans.

Mark Sole and Adina Safer have known all along that they built outside the buildable area. The drawings they submitted in their application for this Variance distorted the true size and nature of this structure, likely as another attempt to hide the size and impact of the structure on their neighbors and the neighborhood.

One should not benefit from one's own wrongdoing. Please revoke 2019-005619VAR.

City and County of
San Francisco

- Home
- Permit Services
- Plan Review
- Inspection Services
- Most Requested
- Key Programs
- About Us

Home » Most Requested

Welcome to our Permit / Complaint Tracking System!

Permit Details Report



Report Date: 1/7/2021 11:55:55 AM

Application Number: 201601046278

Form Number: 8

Address(es): 1529 /025 /0 482 16TH AV

Description: ROTATE BY 90 DEGRESS STAIRS OFF OF 2/F REAR DECK INTO REAR YARD. PA# 201205210880 SHOWS DECK AND PERMITTED STAIR ORIENTATION TO COMPLY WITH NOV 201525661

Cost: \$8,000.00

Occupancy Code: R-3

Building Use: 27 - 1 FAMILY DWELLING

Disposition / Stage:

Action Date	Stage	Comments
1/4/2016	TRIAGE	
1/4/2016	FILING	
1/4/2016	FILED	
3/23/2016	APPROVED	
3/23/2016	ISSUED	
4/7/2016	SUSPEND	per BOA's request dd 04/06/2016, appeal#16-052
11/8/2016	REINSTATED	per Cynthis Goldstein/BOA, Joseph Duffy/DBI's approval, for cancellation purpose by the customer
11/8/2016	CANCELLED	per customer's request, ok'd by Senior Bldg Inspector Joe Duffy

Contact Details:

Contractor Details:

License Number: OWN

Name: OWNER OWNER

Company Name: OWNER

Address: OWNER * OWNER CA 00000-0000

Phone:

Addenda Details:

Description:

Step	Station	Arrive	Start	In Hold	Out Hold	Finish	Checked By	Hold Description
1	INTAKE	1/4/16	1/4/16			1/4/16	CHUNG JANCE	
2	BID-INSP	1/4/16	1/4/16			1/4/16		APPROVEDBY DONAL DUFFY
2	CP-ZOC	1/4/16	1/4/16			1/4/16	OROPEZA EDGAR	new stair and landing as shown on plans. Stair and landing meets section 136(c)(14) - notice is not required in this case per section 311. The applicant has used the rear yard averaging per section 134 - No BBNS.
4	BLDG	3/7/16	3/7/16			3/7/16	WALLS MARK	
5	CPB	3/23/16	3/23/16			3/23/16	YU ZHANG REN	

This permit has been issued. For information pertaining to this permit, please call 628-652-3450.

Appointments:

Appointment Date	Appointment AM/PM	Appointment Code	Appointment Type	Description	Time Slots
------------------	-------------------	------------------	------------------	-------------	------------

Inspections:

Activity Date	Inspector	Inspection Description	Inspection Status
---------------	-----------	------------------------	-------------------

Special Inspections:

Addenda No.	Completed Date	Inspected By	Inspection Code	Description	Remarks
-------------	----------------	--------------	-----------------	-------------	---------

For information, or to schedule an inspection, call 628-652-3400 between 8:30 am and 3:00 pm.

[Station Code Descriptions and Phone Numbers](#)

[Online Permit and Complaint Tracking home page.](#)

Technical Support for Online Services

If you need help or have a question about this service, please visit our [FAQ area](#).

REUBEN, JUNIUS & ROSE, LLP

August 8, 2016

Delivered By E-mail and U.S. Mail

Edmund Louie and Mary Parks
478 16th Avenue
San Francisco, CA 94118
ted.louie@gmail.com

**Re: Appeal No. 16-052_Neighbor Compromise
Our File No.: 10434.01**

Dear Edmund and Mary:

I'm working with your neighbors, Mark Sole and Adina Safer, in connection with your appeal of Building Permit No. 2016/0104/6278 (the "Permit"), which legalizes an existing staircase at the rear of 482 16th Avenue (the "Staircase"). As suggested by the Board on July 14th, your neighbors are reaching out to discuss a compromise.

As you know, the Staircase was built under a larger permit issued in 2012. It was relocated as a field change during construction, to save a mature tree. After your recent complaint, Mark and Adina learned that this required a modification of their 2012 permit. Its omission was an *unintentional oversight due to their inexperience with the permit process and not a willful act to thwart the permit process or injure you*. Mark and Adina were unaware of your objections, as *you did not raise them until over 4 years after the stairs were built*, during settlement negotiations in your former lawsuit. The Permit was granted to correct this oversight.

As DBI and the Planning Department indicated at the July hearing, but for this inadvertent procedural error, the Staircase would have been easily approvable in 2012 with an over-the-counter permit. The Staircase is *Code-compliant, well-constructed, and has been in its current location for over 4 years*.

Further, your concerns are impacted by previous un-permitted additions and rear deck removal on your own building, and your recent decision to remove your property-line fence, which exposed the Staircase.

Under these circumstances, requiring the costly demolition and relocation of the Staircase now would be unreasonably punitive.

James A. Reuben | Andrew J. Junius | Kevin H. Rose | Daniel A. Frattin | John Kevlin
Tuija I. Catalano | Jay F. Drake | Lindsay M. Petrone | Sheryl Reuben¹ | Thomas Tunny
David Silverman | Melinda A. Sarjapur | Mark H. Loper | Jody Knight | Stephanie L. Haughey
Chloe V. Angelis | Louis J. Sarmiento | Jared Eigerman^{2,3} | John McInerney III²

1. Also admitted in New York 2. Of Counsel 3. Also admitted in Massachusetts

San Francisco Office
One Bush Street, Suite 600, San Francisco, CA 94104
tel: 415-567-9000 | fax: 415-399-9480

Oakland Office
827 Broadway, Suite 205, Oakland, CA 94607
tel: 510-257-5589

www.reubenlaw.com

That said, Mark and Adina hope to reach a compromise that addresses your privacy, safety and aesthetic concerns. **They suggest the following reasonable accommodations:**

1. Their removal of the trellis/screening installed above the staircase for your privacy;
2. Their increasing of the trellis/screening to the maximum height allowed by Code for the over-the-counter Permit;
3. Their full cooperation, at their sole expense, with all testing and inspection activities required by DBI to confirm the safety and Code-compliance of the stairs' material and construction;
4. Their agreement to providing appropriate greenery or landscaping on or adjacent to the trellis/screening on their property to increase your privacy;
5. Allowing you to install siding of your choice on the façade of the staircase facing your property, and to paint, stain, or color it to your satisfaction;
6. Allowing you to install appropriate greenery or landscaping (such as ivy or other climbing vines) on the trellis/screening facing your property to increase your privacy;
7. Agreeing not to oppose your construction of your own privacy screen on the stairwell adjacent to your property, to the maximum Code-compliant height;
8. Agreeing not to oppose your installation of fencing on your own property up to the maximum Code-compliant height, *which would cover the entire Staircase*; and
9. Agreeing to make all residents and visitors of 482 16th Avenue aware of your sensitivity to noise and privacy concerns while walking up and down the stairs.

I look forward to discussing these or other options at your convenience, and to reaching a reasonable and fair resolution. Please do not hesitate to contact me by phone at **(415) 567-9000**, or email at **msarjapur@reubenlaw.com**. If you're represented by counsel, please provide their contact information, and I will reach out to them directly.

As you know, the Permit appeal is scheduled to return to the Board on September 14th. Please respond as soon as possible to allow time for a productive discussion.

Very truly yours,

REUBEN, JUNIUS & ROSE, LLP



Melinda Sarjapur

San Francisco Office
One Bush Street, Suite 600, San Francisco, CA 94104
tel: 415-567-9000 | fax: 415-399-9480

Oakland Office
827 Broadway, Suite 205, Oakland, CA 94607
tel: 510-257-5589

www.reubenlaw.com

REUBEN, JUNIUS & ROSE, LLP

Edmund Louie and Mary Parks

August 8, 2016

Page 3

cc: Cynthia Goldstein – Executive Director, Board of Appeals
Pat Buscovich - Engineer
Mark Sole & Adina Safer – Respondents

San Francisco Office
One Bush Street, Suite 600, San Francisco, CA 94104
tel: 415-567-9000 | fax: 415-399-9480

Oakland Office
827 Broadway, Suite 205, Oakland, CA 94607
tel: 510-257-5589

www.reubenlaw.com

REUBEN, JUNIUS & ROSE, LLP

September 9, 2016

Edmund Louie and Mary Parks
478 16th Avenue
San Francisco, CA 94118
ted.louie@gmail.com
mary.parks@gmail.com

To Whom it May Concern:

We are filing a complaint with the City and County of San Francisco Department of Building Inspection because the approved plans for permit 2016/0104/6278 do not match what the owners of 482 16th Avenue built without permit in 2012.

1. The plans show the deck ending well short of the end of our house; the deck as built extends along the property line past our house by approximately 18 inches.

See Permit 2016/0104/6278 Drawing S2.2 and compare with photo in p. 2 of our letter to Mr. Duffy, et al.

2. The plans show the deck ending at the same depth as the extension on the house at 482 16th Avenue; the deck as built extends well past the extension at 482 16th Avenue.

See Permit 2016/0104/6278 Drawing S2.2 and compare with photo in p. 2 of our letter to Mr. Duffy, et al.

3. The plans show the deck being 74 inches deep; we believe the deck as built to be approximately 138 inches deep.

See Permit 2016/0104/6278 Elevation Drawing S3.1 and compare with photo in p. 2 of our letter to Mr. Duffy, et al.

4. The plans indicate that the deck and staircase extend approximately 12 feet out from the main structure at 482 16th Avenue; we believe the deck and staircase as built to extend approximately 20 feet 7 inches out from the main structure.

See Permit 2016/0104/6278 Drawing S2.2 and Elevation Drawing S3.1 and compare with photos in our letter to Mr. Duffy, et al.

5. The plans show the stairs starting their descent short of our house; the staircase as built starts its descent from the end of the deck, approximately 18 inches past our house.

See Permit 2016/0104/6278 Drawing S2.2 and compare with photo in p. 2 of our letter to Mr. Duffy, et al.

6. The plans show 5 steps descending from the deck; the staircase as built has 7 steps descending from the deck.

See Permit 2016/0104/6278 Drawing S2.2 and compare with photo in p. 5 of our letter to Mr. Duffy, et al.

7. The plans show 4 steps descending from the turn; the staircase as built has 2 steps descending from the turn.

See Permit 2016/0104/6278 Drawing S2.2 and compare with photo in p. 6 of our letter to Mr. Duffy, et al.

8. The plans show the stairs extending 6 feet "in to rear yard average;" the deck and staircase as built extend approximately 127 inches past our house and we believe the structural addition violates the rear yard setback of 25%.

See Permit 2016/0104/6278 Drawing S2.2.

9. The plans show the landing for the 90 degree turn to be 30 inches above grade; the landing as built is likely half that height above grade, since there are only two steps descending from the landing, and the bottom step appears to have a riser with a height of approximately 2 inches

See Permit 2016/0104/6278 Elevation Drawing S3.1 and compare with photo in p. 6 of our letter to Mr. Duffy, et al.

10. The plans show a firewall extending at maximum 9 feet 8 inches above grade; as built the structural addition, including deck and staircase, is at maximum more than 10 feet above grade.

See Permit 2016/0104/6278 Drawing S2.2 and Elevation Drawing S3.1.

11. The plans fail to account for the fence/trellis added to the top of the staircase without permit.

See Permit 2016/0104/6278 Drawing S2.2 and compare with photo dated May 19, 2016 at 11:42:22 AM.

12. The plans fail to account for the foundation of the structural addition.

See Permit 2016/0104/6278 Drawing S2.2 and Elevation Drawing S3.1.

13. The plans fail to account for weatherproof siding, and there is no weatherproof siding on our side of the structural addition.

See Permit 2016/0104/6278 Drawing S2.2 and photo dated May 19, 2016 at 11:42:22 AM.

14. The plans fail to account for foundation and exposed firewall built alongside our property where there used to be a fence; this firewall starts at the depth of the sunken patio excavated and built in 2012 at 482 16th Avenue and rises up to and above the deck at a height of approximately 11 feet 6 inches. In addition, the owners of 482 16th Avenue failed to add weatherproof siding to this firewall.

See Permit 2016/0104/6278 Drawing S2.2 and Elevation Drawing S3.1 and compare with photos dated

- a. October 8, 2012 at 7:27:29 PM,
- b. October 8, 2012 at 7:27:47 PM, and
- c. August 7, 2013 at 10:01:15 AM.
- d. For indication of depth of sunken patio, reference photos above and photo taken August 26, 2016 at 6:08:37 PM showing 4 or more concrete steps descending from the rear yard into the sunken patio.

15. The plans show an average of adjacent buildings; after a discussion with N. Moses Corrette in the Planning Department on September 7, 2016, it is our understanding that the average of adjacent buildings cannot be used in this case and is irrelevant.

See Permit 2016/0104/6278 Drawing S2.2 and Elevation Drawing S3.1.

16. In addition to the above, the deck and stairs depicted in permit 2012/0521/0880, filed by the current owners of 482 16th Avenue, show the deck and stairs to remain; in fact both deck and stairs were demolished and rebuilt without matching the footprint depicted in their plans.

See Permit 2012/0521/0880 and compare with

- a. Photo dated September 27, 2011 at 7:43:05 AM and
- b. Photos in our letter to Mr. Duffy, et al.

There is other major work the current owners of 482 16th Avenue did in 2012 without permit that may be of concern:

- A) Demolished and rebuilt their rear extension, possibly enlarging its footprint; see Permit 2016/0104/6278 Drawing S2.2 and Elevation Drawing S3.1 and compare photo dated September 27, 2011 at 7:43:05 AM with photos dated
- a. June 28, 2012 at 7:11:10 PM,
 - b. August 20, 2012 at 12:53:48 PM, and
 - c. August 24, 2012 at 3:56:07 PM.
- B) Added a new slab on the east side of their garage see attached letter from our Structural Engineer.
- C) Demolished and rebuilt parts of the rear of their house; see photos dated
- a. June 12, 2012 at 8:39:20 PM and
 - b. October 8, 2012 at 7:27:29 PM.

Sincerely,
Edmund (Ted) Louie and Mary Parks



Edmund Louie



Mary Parks

Attachments:

- Letter from our Structural Engineer dated February 5, 2015 filed with Complaint 201525661—3 pages
- Our letter sent August 30, 2016 to Mr. Joseph Duffy (DBI), Mr. Scott Sanchez (Planning Department), and Ms. Cynthia Goldstein (Board of Appeals)—7 pages
- Photos dated—7 pages
 - September 27, 2011 at 7:43:05 AM
 - June 12, 2012 at 8:39:20 PM
 - June 28, 2012 at 7:11:10 PM
 - August 20, 2012 at 12:53:48 PM
 - August 24, 2012 at 3:56:07 PM
 - October 8, 2012 at 7:27:29 PM
 - October 8, 2012 at 7:27:47 PM
 - August 7, 2013 at 10:01:15 AM
 - May 19, 2016 at 11:42:22 AM
 - August 26, 2016 at 6:08:37 PM
- Our hand-drawn renditions of Permit 2016/0104/6278 Drawing S2.2 and Elevation Drawing S3.1—2 pages

KEMBCON ENGINEERS
STRUCTURAL AND CIVIL ENGINEERS
P.O. BOX 389
MILLBRAE, CA 94030
650-343-8310 (voice)
650-343-8312 (fax)
engineers@kembcon.com

5 February 2015

To Whom It May Concern:

I am the engineer of record for the repair of the foundation at 478 16th Avenue, in San Francisco, CA. On 22 January 2015, I met with the owners of 478 16th Avenue at the San Francisco Department of Building Inspection.

Together we reviewed the building permit files for the three buildings at 478, 482 and 486 16th Avenue.

We learned that all three building were constructed under permits issued on August 26, 1911. This was after the 1906 earthquake, when the City was expanding out onto the sand dunes to the west of the existing developed area.

Since the damage to the building at 478 16th was caused by the undermining of its foundation during the excavation at 482 16th, we looked at the permit file to determine what construction was authorized by permit.

We found that a building permit was issued for exploratory demolition in 2012. This was to allow the owners to determine the depth and extent of the existing foundations at the area where the ceiling height was to be increased.

We found that a second permit was issued on April 19, 2013 for changing the rear roof to a roof deck. This plan shows the existing straight run stair to the backyard to remain.

We found that a third permit was issued on May 11, 2012. for the work at the lower floor of 482 16 th Avenue. Plans were prepared by DD Engineering. Plans showed that the work would not affect the foundation at the side adjacent to 478 16th. Details 3 and 4 on sheet S2 showed that they proposed to leave the existing trapezoidal foundation and dowel the new slab into it.

At the property line between 482 16th and 486 16th, the foundation was to be undermined only at the extreme rear, where the new habitable space was to be created.

On Sheet S2, there is a note by the details for the foundation work that reads:

"Where undermining occurs:

- 1. Verify cohesive soils below neighbor's footing. Pour new foundation in 8'-0" maximum sections.**
- 2. Provide shoring and/or epoxy soil injection under separate permit where cohesionless soils occur.**
- 3. Owner of adjacent property shall be notified 30 days prior to commencement of excavations. "**

On May 21, 2012, a fourth permit was issued based on plans by Artistic Designs were submitted showing interior remodel work. These plans showed:

- Existing straight stair to rear yard to remain.**
- No new slab at east side of garage**
- Deck at rear is existing**
- New bathroom , playroom and workout room to be constructed in the garage area.**
- A wet bar was proposed but denied by the Planning Department.**

On July 25, 2012, a fifth permit was issued based on plans by DD Engineering. These plans show that the footing between 482 16th Avenue and 478 16th Avenue was to be undermined "2'-5" maximum". The existing trapezoidal footing of 482 16th was to be demolished in three separate operations and replaced with a new "elf" shaped foundation wall. The same notes were shown on the plan:

"Where undermining occurs:

- 1. Verify cohesive soils below neighbor's footing. Pour new foundation in 8'-0" maximum sections.**
- 2. Provide shoring and/or epoxy soil injection under separate permit where cohesionless soils occur.**
- 3. Owner of adjacent property shall be notified 30 days prior to commencement of excavations. "**

The plans show that the old foundation is to be demolished and the new foundation to be constructed in three separate sections.

The plans show the existing straight stair to the rear yard to remain.

The plans show the existing trapezoidal foundation at 478 16th Avenue to remain.

Based on my review of the approved permit plans and upon examination of the photographs which my clients showed me and upon my visual inspection of the present conditions and the documents which my clients found on the web and printed out, I conclude the following:

The owners of 482 16th Avenue or their contractors:

- **Constructed an illegal second unit in the lower level of their dwelling and are offering it for rent on the internet**
- **Demolished the existing straight stairway to their rear yard and constructed a new dog leg stairway inside the side yard setback without obtaining a permit for this work.**
- **Changed the door and window at the lower floor of the illegal unit without a permit**
- **Undermined the foundation of 478 16th Avenue without either underpinning, grouting or shoring the existing foundation.**
- **Demolished and removed almost all the foundation at the North side of at 478 16th Avenue without obtaining a demolition permit**
- **Shored the lower floor of 478 16th Avenue without a building permit**

The undermining of the foundation occurred because the soil in the area, as in much of the Richmond, is free running dune sand. This is about as distant from "cohesive" soil as it could possibly be.

It is my professional opinion, as a retired general contractor, as a registered civil and structural engineer and a long time member of first the ICBO and later the ICC, that the owners of 482 16th Avenue did work without a permit, exceeded the scope of the permits that they did have and deliberately violated the San Francisco Planning Ordinance.

Sincerely,

**Eric Cox, RSE
President**



FEB 05 2015

2016/0104/6278
Drawing S2.2
(Proposed)

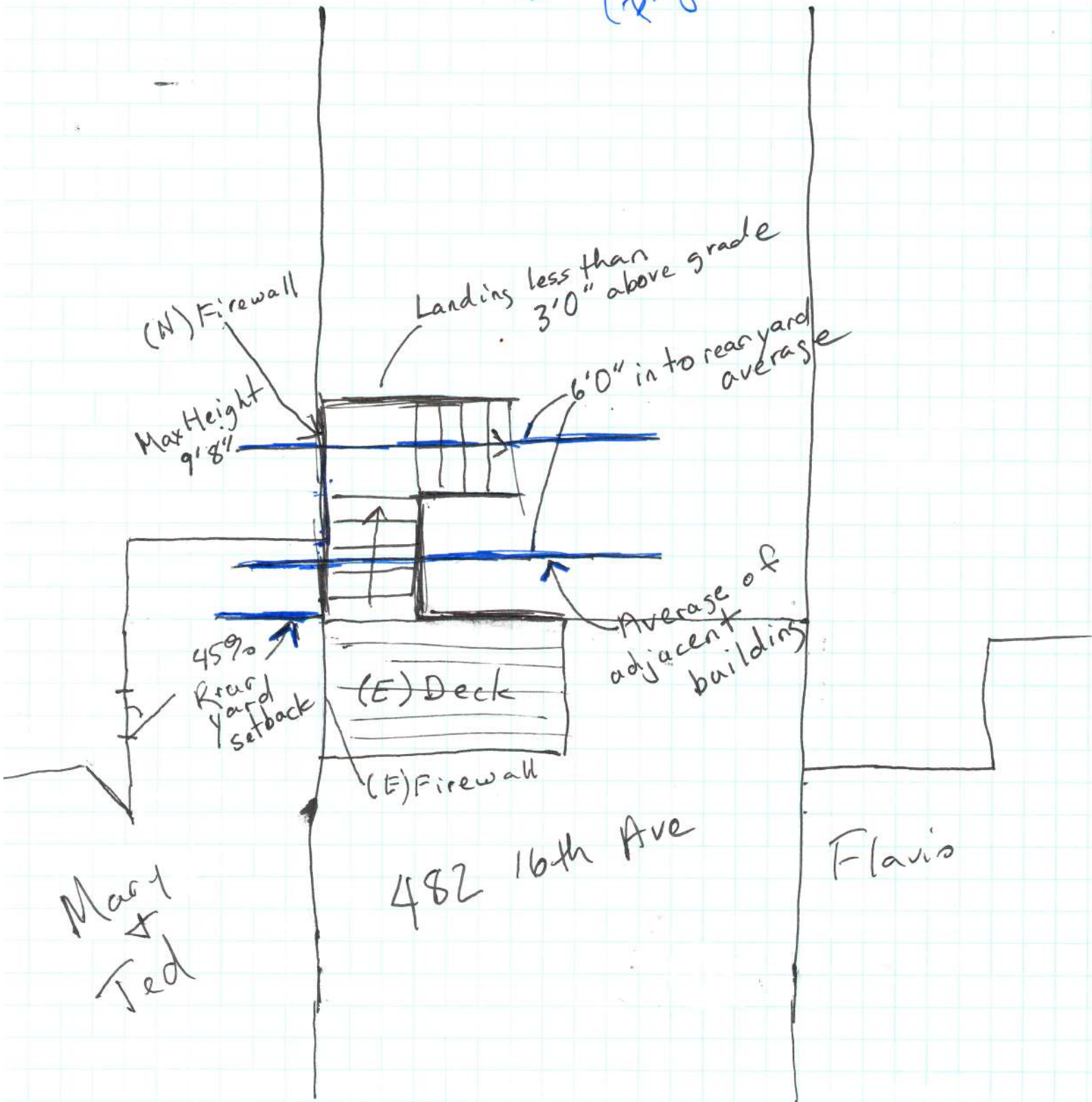

③ Saw Section

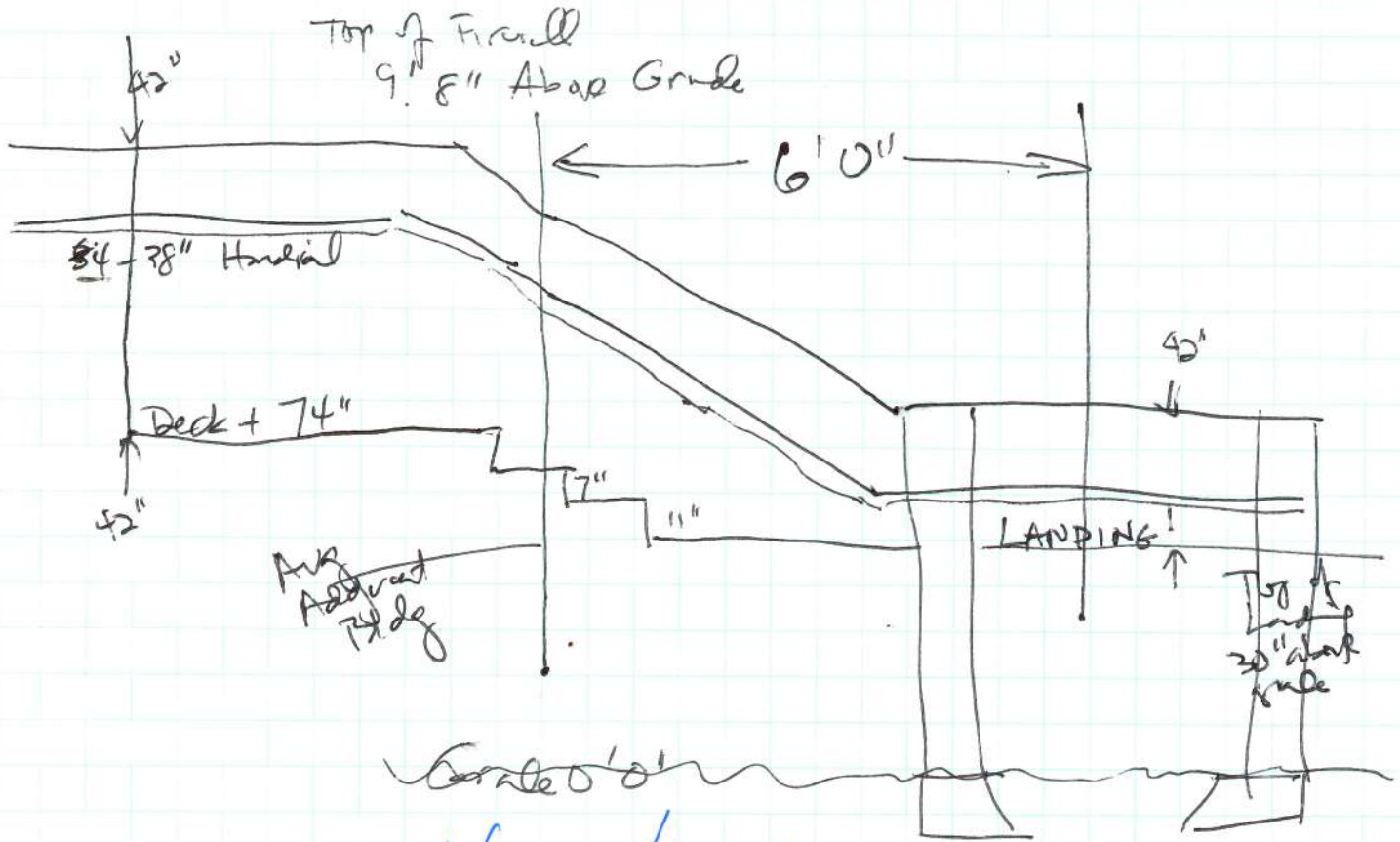

2016/0104/6278
S3.1 Elevation

Mr. Sanchez, Mr. Duffy, and Ms. Goldstein,

We have copied our structural engineer.

As you know, we've filed Appeal 16-052 in response to permit 2016/0104/6278, and the Board voted to continue our appeal to the September 14 Board meeting.

We reviewed the plans on file again and have found that they seriously misrepresent what the owners of 482 16th Avenue built and call into question claims that the staircase and deck are code-compliant. Of greatest concern:

- 1) The plans show the deck ending short of our house, but in fact the deck projects approximately 18 inches past our building on the property line
- 2) Per Mr. Sanchez, the plans meet a requirement for stairs to project no more than 6-feet into the yard; but in fact the structural addition extends along the property line for approximately 127 inches past our house

Here are the details.

Size of deck

In drawing S2.2, of the "proposed" plan, the deck is shown, as Mr. Sanchez described at the Board meeting, to be shallower than our property.

However, on observation, the deck extends past our building by approximately 18 inches.

Please review the plan and compare it with the photograph below taken from the property immediately south of the subject property.



In the photo above, our house is to the north of the deck at 482 16th Avenue, with brown shingles on its side. The firewall with siding is against our building. The deck and firewall extend well past our building, before the staircase starts its

descent. Mr. Buscovich's plans, which show a shallower deck ending before our building, misrepresent what was built.

Projection into rear yard

At the hearing, shortly after 03:40:36 in the recording, Mr. Sanchez stated that the code allows for a staircase from the first living level to project into the yard 6 feet and that the plans provided by Mr. Buscovich met that code requirement.

However, when we measure the structural addition from our side, it extends along the property line 127 inches from our house, well over 6 feet. On observation, we see a number of misrepresentations in the plans that may account for this difference.

Please review the plans and compare them with the photographs shown below taken from the property immediately south of the subject property. (For your convenience, the photo above is again copied below).



The photo above shows the deck and firewall extending past our building an estimated 18 inches, after which the staircase starts its descent into the yard. In contrast, the plans show the deck ending short of our building and the staircase starting its descent short of our building as well.

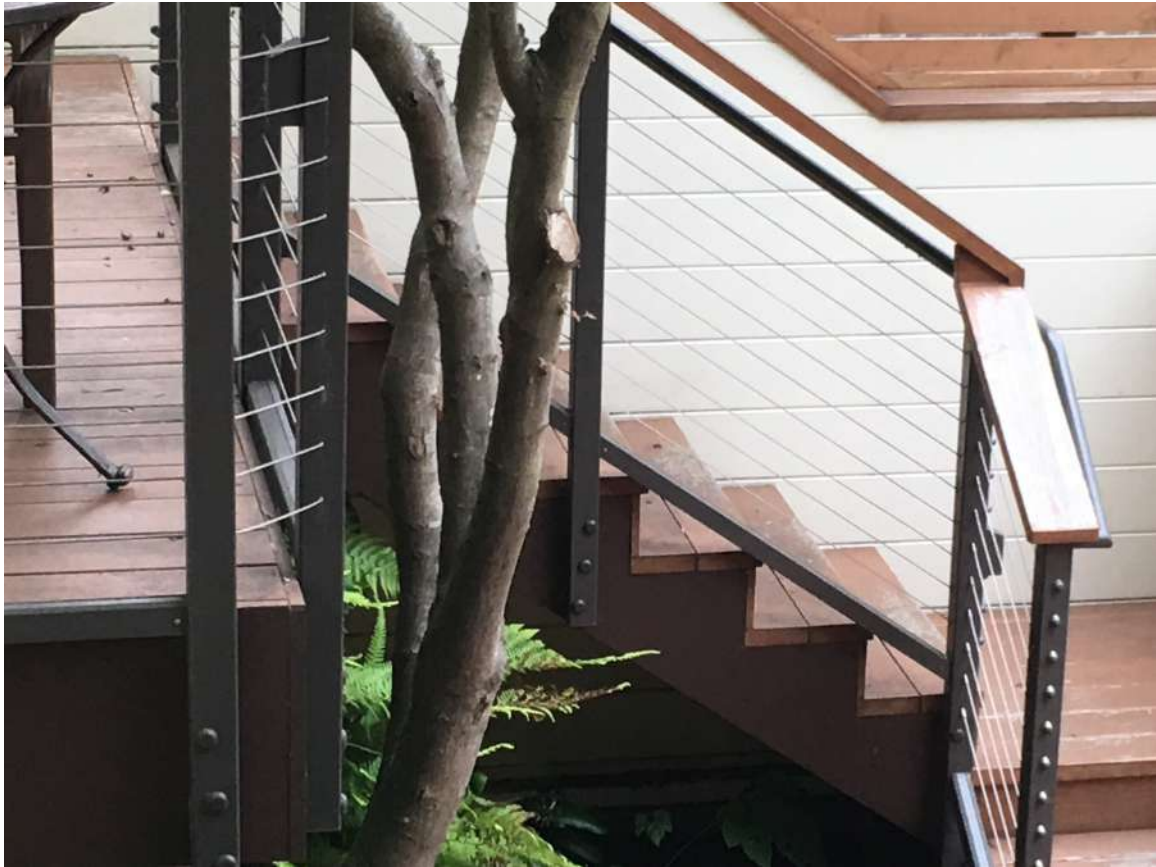

The photo above shows 7 steps descending to the landing. In contrast, the plans show 5 steps going down to the landing.



The photo above shows 2 steps after the turn. In contrast, the plans show 4 steps after the turn.

Again, the plans, showing the stairs extending a shorter distance than they actually do, significantly misrepresent what was built.

Aside from the deck and staircase not matching what is on the plans, we have serious questions over claims that the deck and stairs are code-compliant and well constructed.

Scope of work under 2012 permits

We also would like clarification from the Planning Department and DBI regarding the scope of work under the permits granted in 2012. Permit 2012/05/21/0880 is described as "UPGRADE KITCHEN, BATHROOMS, BEDROOMS, INSULATION, ELECTRICAL, PLUMBING, FLOORING & WINDOWS. REPLACING FIXTURES IN KIND, NO STRUCTURAL"

When the owners of 482 16th Avenue demolished and rebuilt the deck and stairs in 2012, is that "structural"?

We ask because in his brief to the Board, Mr. Buscovich wrote: "This original position to build the staircase is as shown in a 2012 permit (2012/05/21/0880). This permit shows existing stair and deck and new stair and deck."

He also claimed a number of times before the Board that a new stair and deck were in-scope under the permits in 2012.

We reviewed all the current owners' permits from 2012/2013 and not one allows for either the demolition of the original deck and stairs or the erection of replacements. The original deck and stairs are designated to remain.

Our structural engineer made the same observations in our original complaint (Exhibit J in our Board brief).

Conclusion

We respectfully ask that you please investigate these questions before our scheduled appearance before the Board September 14th and apprise the Board and us of what you find.

We are available if needed to meet with any of you and answer any questions you may have.

This letter doesn't include other discrepancies we found and questions which arise, including but not limited to the actual height of the structure and fence, the materials used in their construction, the lack of weatherproof material on our side of the structure, the actual depth of the lower patio and lower unit, and the location of the concrete steps coming up from the lower patio. We wanted to keep this letter short.

Thank you for your time and attention.

Edmund (Ted) Louie and Mary Parks

415-260-5497

415-260-1098



June 12, 2012 at 8:39:20 PM



August 20, 2012 at 12:53:48 PM



August 24, 2012 at 3:56:07 PM



October 8, 2012 at 7:27:29 PM



October 8, 2012 at 7:27:47 PM



August 7, 2013 at 10:01:15 AM



May 19, 2016 at 11:42:22 AM



August 26, 2016 at 6:08:37 PM



September 7, 2016

Delivered by E-mail and U.S. Mail

Edmund Louie and Mary Parks
478 16th Avenue
San Francisco, CA 94118
ted.louie@gmail.com
mary.parks@gmail.com

Reuben, Junius & Rose, LLP
Attention: Melinda Sarjapur
One Bush Street, Suite 600
San Francisco, CA 94104
msarjapur@reubenlaw.com

Re: Appeal No. 16-052

Ms. Sarjapur:

This will respond to your letter dated August 8, 2016. We've copied Cynthia Goldstein of the Appeals Board with our response, as she was copied in your letter to us.

To resolve our Appeal, we request that the owners of 482 16th Avenue relocate the rear stairs to the position shown in the approved plans of 2012, scale back their deck per the approved plans of 2012, and replace the 6-foot fence that had separated our properties.

All work and construction shall follow all legal processes and be made per code, including only licensed contractors, written contracts/change orders as required by law, and no "under-the-table" payments--as was the case before.

Alternately, if your clients have plans they can show us with a different location for the stairs that will be code compliant and not require a firewall, we would be willing to consider those plans after being afforded time to go over them with our design and construction professionals.

We considered the suggestions in your letter, but they do not address our concerns at all; if anything they exacerbate them in that the as-built un-permitted staircase is not code-compliant and presents a hazard. Further, the structural addition does not follow the Design Principles in the Planning Department's Residential Planning Guidelines (p.5):

A) "Ensure that the building's scale is compatible with surrounding buildings."

The scale of your clients' structural addition and fence/trellis is not compatible with the surroundings, extending 127 inches past our building along our property line and standing at or near 10 feet above grade. Moreover, we believe the structural addition is in violation of Planning Code Section 136. Your clients' suggestion to build a higher fence along the rest of the property line is also not compatible.

B) "Ensure that the building respects the mid-block open space."

Your clients' structural addition, including staircase, enlarged deck, and fence/trellis on top of the firewall, extends 127 inches past our building along our property line and stands at or near 10 feet above grade, diminishing the open space. Moreover, we believe the structural addition is in violation of Planning Code Section 136. And your clients' suggestion to build a higher fence along the rest of the property line would further block the open space.

C) "Maintain light to adjacent properties by providing adequate setbacks."

Your clients' structural addition does not provide the required rear yard setback of 25%. Moreover, we believe the structural addition is in violation of Planning Code Section 136. And your clients' suggestion to build a higher fence along the rest of the property line would further block our light.

D) "Provide architectural features that enhance the neighborhood's character."

Our neighborhood is characterized by common fences between properties. Your clients' structural addition and fence/trellis, extending approximately 127 inches past our building along our property line and standing at or near 10 feet above grade, go against our neighborhood's character. Moreover, we believe the structural addition is in violation of Planning Code Section 136.

We have no interest in re-hashing the arguments already presented to the Board of Appeals, but your letter contains many false statements and self-serving inaccuracies, which we dispute. We believe it is important to set the record straight.

(1) You incorrectly state that "the Staircase was built under a larger permit issued in 2012."

Actually, none of the 4 building permits your clients took out in 2012/2013 allow for:

- (a) the demolition of the then-existing stairs;
- (b) the rebuilding of the stairs; or
- (c) the relocation of the stairs as a structural addition.

In addition, none of these permits allow for the demolition and rebuilding of your clients' deck and rear of house.

As our structural engineer, Eric Cox, wrote in his letter as part of our complaint, dated February 5, 2015, your clients “[d]emolished the existing straight stairway to their rear yard and constructed a new dogleg stairway inside the side yard setback without obtaining a permit for this work.” Further, he concludes “that the owners of 482 16th Avenue did work without a permit, exceeded the scope of the permits that they did have and deliberately violated the San Francisco Planning ordinance.” Please see Exhibits B and J in our brief to the Board.

As was repeatedly stated on July 13 by Board Commissioners and by SFDBI, your clients demolished the wooden stairs and rebuilt them as a structural addition, all without a permit.

(2) You incorrectly assert as fact that “[t]he Staircase is Code-compliant.”

The structural addition your clients built in 2012 does not meet the required rear yard setback of 25%. Moreover, we believe the structural addition is in violation of Planning Code Section 136.

The plans your clients submitted for permit application 2016/0104/6278, drawing S2.2 misrepresent the physical construction of the structural addition, making it appear that the staircase your clients built does not extend as far back in their rear yard as it actually does. Moreover, this drawing misrepresents the size of the deck your clients built in 2012, making it appear shallower than it actually is, concealing that it extends well over 18 inches past our house.

As DBI and the Planning Department stated at the July 13 hearing, no one from their departments has ever inspected the staircase as built. DBI also made it clear that the sign-off of the permits in 2013 should not have happened and that the relocation of the staircase as a structural addition by your clients “should have been caught” (around 3:39:53 in video).

At the hearing, DBI stated that if the structural addition is not built per plan, it would result in a correction notice, and if not up to code, it would result in a notice of violation (around 3:32:05 in video).

Both DBI and the Planning Department relied on the plans submitted by your clients, which misrepresented the size of the deck and the distance the staircase

projects into your clients' rear yard, and omitted the fence/trellis atop the structure.

In all of the 2012 plans submitted by your clients, the then-existing deck is shown to be the same depth as our house. In the 2016 plans submitted by your clients, the deck is inaccurately shown to stop short of the end of our house.

In fact, the deck your clients actually built in 2012 without permit has a greater depth than the deck shown in both the 2012 plans and the 2016 plans, projecting into your clients' yard and extending at least 18 inches along the property line past our house. Every single time anyone over 42 inches tall approaches the stairs or starts to walk down, they look directly down into our backyard, which is intrusive and invasive of our privacy.

Furthermore, the plans your clients submitted in 2016 incorrectly show the un-permitted staircase your clients built in 2012 starting its descent short of the end of our house. In fact, the staircase that your clients built in 2012 starts its descent from the deck more than 18 inches past our house.

In addition, the plans your clients submitted in 2016 incorrectly show the staircase having 5 steps that descend from the deck, and then 4 steps descending after the turn, making its projection into your clients' rear yard appear shorter than it actually is. In fact, the staircase your clients built in 2012 has 7 steps descending from the deck, and 2 steps descending after the turn.

The distance from the rear of our house to the end of the firewall that encases the enlarged deck and staircase is approximately 127 inches. The plans misrepresent how far the deck and staircase actually go into your clients' yard, making it appear the staircase meets code requirements.

In addition to the above, the plans your clients submitted in 2016 fail to show the fence/trellis your clients built on top of their staircase. As was stated at DBI, the fence/trellis requires its own permit or a change to the permit (around 3:33:29 in video). No plans have been submitted for the fence/trellis, and at this time it is unknown whether such a fence/trellis meets the requirements for combustible construction along a shared property line.

Your assertion that your clients' staircase is code-compliant is not factual.

(3) You incorrectly assert as fact that the staircase your clients built in 2012 is "well constructed."

There is no evidence the materials used in the construction of the firewall, nor the construction itself, are code-compliant, much less well constructed. Our structural

engineer believes that the firewall as built does not comply with building codes nor does our side of the firewall have any weatherproof siding, as is required.

At the hearing on July 13, DBI also indicated that the firewall construction had certain requirements, including but not limited to siding that goes over the underlying material (around 3:31:52 in video). There is no siding on our side of the firewall.

Furthermore, DBI stated that the foundation of the structural addition needs to be inspected, and that the siding has to be removed to inspect the construction underneath (around 3:38:49 in video).

DBI also stated that the fence your clients built on top of the staircase/deck firewall would have to have plans drawn up and go through a permitting process were it to remain (around 3:32:05 in video). No one has ever seen any plans for that fence on top of the staircase, much less evidence that it is code-compliant or well built. Moreover, no one has had the opportunity to determine how that fence impacts the code-compliance of the overall structural addition and firewall your clients built.

Your claim that the staircase your clients built is well constructed ignores the fact that it is illegal and is merely a bald, unsupported assertion not based on any facts.

(4) You incorrectly state that the un-permitted stairs were "relocated as a field change during reconstruction, to save a mature tree."

Even if one of these permits allowed the demolition and rebuilding of your clients' stairs, which none did, the tree would scarcely have prevented your clients from rebuilding the stairs in their prior location, since the tree and stairs co-existed in 2011, per our Exhibit A.

All the plans submitted by your clients in 2012/2013 show the stairs in their prior location in the middle of the yard with the existing tree marked clearly next to them, with stairs and tree both to remain. Blaming this tree for your clients' failure to follow their own plans in 2012 is highly disingenuous, since **the tree was accounted for in their plans.**

Furthermore, as was indicated by your clients' representative on July 13, 2016, in 2012 your clients built new concrete steps leading up from their illegal lower unit/short term rental's lower patio in the same location where their plans show the straight stairs from the deck, which was supposedly to remain in place unchanged.

None of the plans submitted to the city in 2012/2013 show these steps leading from this lower-level patio. Nor do the plans submitted in 2016 show these steps. It was only during the hearing of July 13, 2016, that we learned of the existence of these steps.

As noted by Board Commissioners, the original stairs on your clients' property were demolished without a permit and new stairs were relocated and built at the "arbitrary will" of your clients (around 3:37:06 in video). Your statement about the impetus behind the relocation being to save a mature tree seems patently untrue.

(5) You write that "DBI and the Planning Department indicated at the July hearing, but for this inadvertent procedural error, the Staircase would have been easily approvable in 2012."

It is our understanding from the Planning Department that had your clients followed the permitting process for an enlarged deck and staircase structural addition of this kind in 2012, the Planning Department would have sent a public notification, which we would have answered.

Also, DBI stated at the Board of Appeals meeting on July 13 that had your clients followed the planning process in 2012 and filed a change to the permit showing the structural addition of a staircase at the property line, DBI would have sent us a Notice of Structural Addition (around 3:53:18 in video).

In both these instances we would complained or appealed, but because of your clients' disregard for the planning and permitting process, our rights to do so were taken from us. The location of the staircase, and the enlargement of the deck past our house, is uncharacteristic for our neighborhood, has major aesthetic problems, violates our privacy, decreases the security of our property, creates a potential hazard, and negatively impacts the value and enjoyment of our home.

Finally, as was indicated by Board Commissioners, had the Board been given the opportunity in 2012, they would have returned the stairs to their original position in the middle of your clients' yard (around 3:56:26 in video).

(6) You incorrectly state that we "did not raise...[our complaint] until over 4 years after the stairs were built."

We filed our complaint to SFDBI in February 2015, approximately 2 years and 4 months after your client erected the un-permitted staircase, not "over 4 years after the stairs were built" as you incorrectly state.

After we filed Complaint 201525661 with SFDBI in February of 2015, we regularly checked on the status of our complaint and contacted the City a number of times.

It was not until March of 2016 that we received a Notification of Structural Addition from SFDBI, which described a permit for a change to the orientation of the stairs, and appeared to be an attempt by your clients to respond to our complaint by seeking approval for the un-permitted staircase after-the-fact.

Had your clients followed proper procedure in 2012 and amended their permits or filed for new permit for the structural addition of the stairs, we would have received a Notice of Structural Addition from SFDBI in 2012, similar to the one we received in 2016, and would have appealed at the time.

The main reason we didn't raise the issue of the stairs at the time they were built was, as we stated at the Board of Appeals hearing, we were facing a much more perilous problem caused by your clients' doing.

--Your clients undermined not only our home, but also the house to their south, causing extensive damage not only to both foundations, but also the upper floors of both homes.

--Your clients went on to completely demolish the remainder of our foundation along the property line without our consent and in violation of a Stop Work Order issued by SFDBI, causing further damage to our home.

--In 2012, your clients also trespassed on and damaged our roof. They also damaged the roof of their neighbor to the south.

--During their remodeling work, your clients progressively damaged and demolished sections of our fence, removing planks and fencing in the same location where the un-permitted staircase stands today, and causing remaining portions of the fence to severely lean over into our back yard. Please see Exhibits B, F, and K.

--After damaging and removing planks from our fence, your clients and their workers trespassed onto our property and left sand and construction debris in our yard.

By the time your clients erected their un-permitted stairway and deck, they had literally damaged our home from top to bottom, front to back, and we were desperately trying to prevent more damage.

(7) You state that your clients' actions were "an unintentional oversight due to their inexperience with the permit process and not a willful act to thwart the permit process or injure you."

In fact, your clients have failed to correct these errors, even in this most recent permit application.

In permit 2013/0408/3981, well after your clients had built the un-permitted staircase, they failed to correctly show the City that they had relocated the staircase to the property line. The stairs were still shown as an existing straight run from the middle of the property, not a dogleg on the property line. These plans also failed to show the enlargement of your clients' deck, which extends more than 18 inches past our building on the property line. And your clients never filed for or obtained a permit to demolish and rebuild their deck, much less to enlarge it.

In permit application 2016/0104/6278, drawing S2.1, your clients again show the purported "existing" stairs as still being located in the middle of their property when in fact they are not, but rather are located on the north property line. These plans also fail to show the enlargement of your clients' deck.

Moreover, in permit application 2016/0104/6278, drawing S2.2, your clients misrepresent the physical structure of the un-permitted deck and staircase they built in 2012, disingenuously making it appear that the deck and staircase meet the 25% rear yard setback requirement and are code-compliant. The plans falsely show a deck that ends short of our house, and the staircase starting its descent short of our house as well. Moreover, these plans inaccurately show only 5 steps descending from the deck, then 4 steps after the turn.

In fact, the deck extends at least 18 inches past our house, after which the staircase starts its descent. And the staircase actually has 7 steps descending from the deck, not 5; it has 2 steps after the turn, not the 4 shown.

And all of their drawings fail to show the un-permitted fence/trellis that your clients' built on top of their staircase/firewall.

Your statement that your clients are finally addressing a past "unintentional oversight" and that their failure to follow the permitting process is not "a willful act" is simply not credible. **Your clients, along with their engineer, Mr. Pat Buscovich, failed to take advantage of this latest opportunity through the permitting process to address their other supposed oversights: their enlarged deck and the fence/trellis built on top of the staircase/firewall. In fact, their recent plans for the staircase conceal these items and misrepresent how far the structural addition extends into the rear yard.**

Moreover, in 2012, while your clients were trying to pressure us to give them carte blanche control over the replacement of our south foundation—the foundation they had undermined and damaged beyond repair, they repeatedly offered to file permit applications for our foundation replacement on our behalf, claiming that they had great knowledge and understanding of the permit process and on how to move things along quickly at DBI and the Planning Department. Moreover, your clients acted as their own general contractor and retained the

permits for their 2012 remodel project as an Owner-Builder. Your statement that your clients were unfamiliar with the permit process is not credible.

In light of the above, it is clear that your clients were, and are still, attempting to mislead and circumvent the permit and planning processes, and now the appeals process. As we all heard at the meeting, the Board has ordered similar un-permitted structures disassembled and relocated in the very recent past (around 3:37:06 in video).

Your clients also repeatedly fail to follow rules, processes, and laws. Here are some such actions they have taken in the past, and the list is not exhaustive:

- Your clients failed to notify both us and their southern neighbor in a timely manner of the need to underpin our foundations;
- They never underpinned either of our foundations as was indicated in their plans by their structural engineers as a requirement;
- They undermined and severely damaged our south foundation and tried to pressure us into signing a letter giving them carte blanche control over the repair;
- They demolished and removed our south foundation without our permission and in violation of a Stop Work order;
- They progressively damaged and demolished sections of our fence, in the same location the new stairs were eventually built;
- They constructed an illegal second unit on their lower-level and offered it as a short-term rental on the Internet; and
- They never listed their short-term rental unit with the City.

As was stated at the hearing on July 13, demolishing the stairs, moving them, and rebuilding them as a structural addition, is a case of your clients' basically saying "let's do it and pray for forgiveness later" (around 3:37:36 in video). As the Board stated then, the Board has required the dismantling and relocation of un-permitted structures in the recent past.

(8) You incorrectly write about "previous un-permitted additions and rear deck removal" on our building, but the footprint of our house has not changed since approximately 1913-15, per the Sanborn maps. Furthermore, we have never had a rear deck.

(9) You write that the removal of our fence along the property line "exposed the staircase." As stated above, your clients and their construction workers severely damaged our fence and demolished sections at the same location where the stairs and firewall were erected. Your clients never made any attempt whatsoever to repair the damage they caused to our fence. The removal of this fence debris is irrelevant and has no impact on our original complaint or on our Appeal.

We believe our position to be very reasonable under the circumstances.

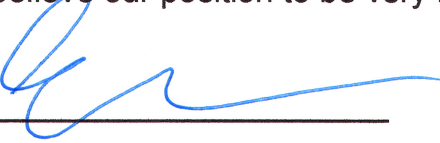

Edmund Louie



Mary Parks

Cc: Cynthia Goldstein—Executive Director, Board of Appeals
Pat Buscovich—Engineer
Mark Sole & Adina Safer—Respondents

City and County of San Francisco

- Home
- Permit Services
- Plan Review
- Inspection Services
- Most Requested
- Key Programs
- About Us

Home » Most Requested

Welcome to our Permit / Complaint Tracking System!

COMPLAINT DATA SHEET



Complaint Number: 201635992
Owner/Agent: OWNER DATA SUPPRESSED
Owner's Phone: --
Contact Name: --
Contact Phone: --
Complainant: COMPLAINANT DATA SUPPRESSED

Date Filed:
Location: 482 16TH AV
Block: 1529
Lot: 025
Site:
Rating:
Occupancy Code:
Received By: Czarina Blackshear
Division: BID

Complainant's Phone:
Complaint Source: TELEPHONE
Assigned to Division: CES

Description: Approved bldg PA #201601046278 do not match as-built. Deck = 74" in plans, 120" actual; 5 steps descending in plans, 7 actual. Missing foundation, trellis, waterproofing. Firewall over >10ft above grade. (see attached)

Instructions:

INSPECTOR INFORMATION

DIVISION	INSPECTOR	ID	DISTRICT	PRIORITY
CES	HINCHION	1125		

REFERRAL INFORMATION

DATE	REFERRED BY	TO	COMMENT
11/28/2018	Suzanna Wong	CES	Per Michael Chan

COMPLAINT STATUS AND COMMENTS

DATE	TYPE	DIV	INSPECTOR	STATUS	COMMENT
09/09/16	CASE OPENED	BID	Walsh	CASE RECEIVED	
09/12/16	OTHER BLDG/HOUSING VIOLATION	BID	Walsh	CASE CLOSED	The permit referenced in complaint is currently suspended. KM/jj
09/14/16	OTHER BLDG/HOUSING VIOLATION	BID	Duffy	CASE UPDATE	Spoke to complainant and it is anticipated that plans will be ordered to review earlier permits. A site visit will be arranged in early October.grsamaras for J. Duffy
09/14/16	OTHER BLDG/HOUSING VIOLATION	BID	Walsh	CASE UPDATE	Reopened and assigned to J. Duffy, per his request.grs
11/02/16	OTHER BLDG/HOUSING VIOLATION	BID	Duffy	FIRST NOV SENT	1st NOV issued by J. Duffy. G samaras
11/04/16	OTHER BLDG/HOUSING VIOLATION	BID	Duffy	CASE UPDATE	1st NOV mailed. g samaras
11/28/18	GENERAL MAINTENANCE	BID	Duffy	CASE UPDATE	Final warning letter mailed; slw
11/28/18	OTHER BLDG/HOUSING VIOLATION	BID	Duffy	REFERRED TO OTHER DIV	Referred to CES per MChan; slw
11/28/18	OTHER BLDG/HOUSING VIOLATION	BID	Duffy	FINAL WARNING LETTER SENT	Final warning letter issued by M.Chan; slw
11/29/18	GENERAL MAINTENANCE	CES	Hinchion	CASE RECEIVED	Case to be review by CES Sr. Inspector -AKW
12/31/18	GENERAL MAINTENANCE	CES	Hinchion	CASE UPDATE	Received file from Insp. 12/31/2018 & prepared DH for 1/15/2019 & mailed -AKW
12/31/18	OTHER BLDG/HOUSING VIOLATION	CES	Schroeder	REFER TO DIRECTOR'S HEARING	schedule DH 1/15/19 cs
01/03/19	OTHER BLDG/HOUSING VIOLATION	CES	Schroeder	DIRECTOR HEARING NOTICE POSTED	post DH cs
01/15/19	OTHER BLDG/HOUSING VIOLATION	CES	Schroeder	CASE CONTINUED	cases continued per letter dated 1/7/19 to 2/19/19 cs
01/29/19	GENERAL MAINTENANCE	CES	Hinchion	CASE UPDATE	Prep DH-Cont 2-19-19 & mail -AKW
02/19/19	OTHER BLDG/HOUSING VIOLATION	CES	Schroeder	ORDER OF ABATEMENT ISSUED	OOA issued per HO DL cs
03/05/19	GENERAL MAINTENANCE	CES	Hinchion	CASE UPDATE	Prep & Cert Mail OOA+INT+MMF -akw
03/06/19	OTHER BLDG/HOUSING VIOLATION	CES	Schroeder	ORDER OF ABATEMENT POSTED	OOA posted cs
04/18/19	OTHER BLDG/HOUSING VIOLATION	CES	Hinchion	CASE UPDATE	processed mmf & initial bill payments -mor
10/28/19	OTHER BLDG/HOUSING VIOLATION	CES	Schroeder	ABATEMENT APPEALS BOARD HRG	AAB post cs

COMPLAINT ACTION BY DIVISION

NOV (HIS): **NOV (BID):** 11/07/16

Inspector Contact Information

[Online Permit and Complaint Tracking home page.](#)

Technical Support for Online Services

If you need help or have a question about this service, please visit our [FAQ area](#).



June 4, 2009 at 4:33:09 PM



September 27, 2011 at 7:43:05 AM



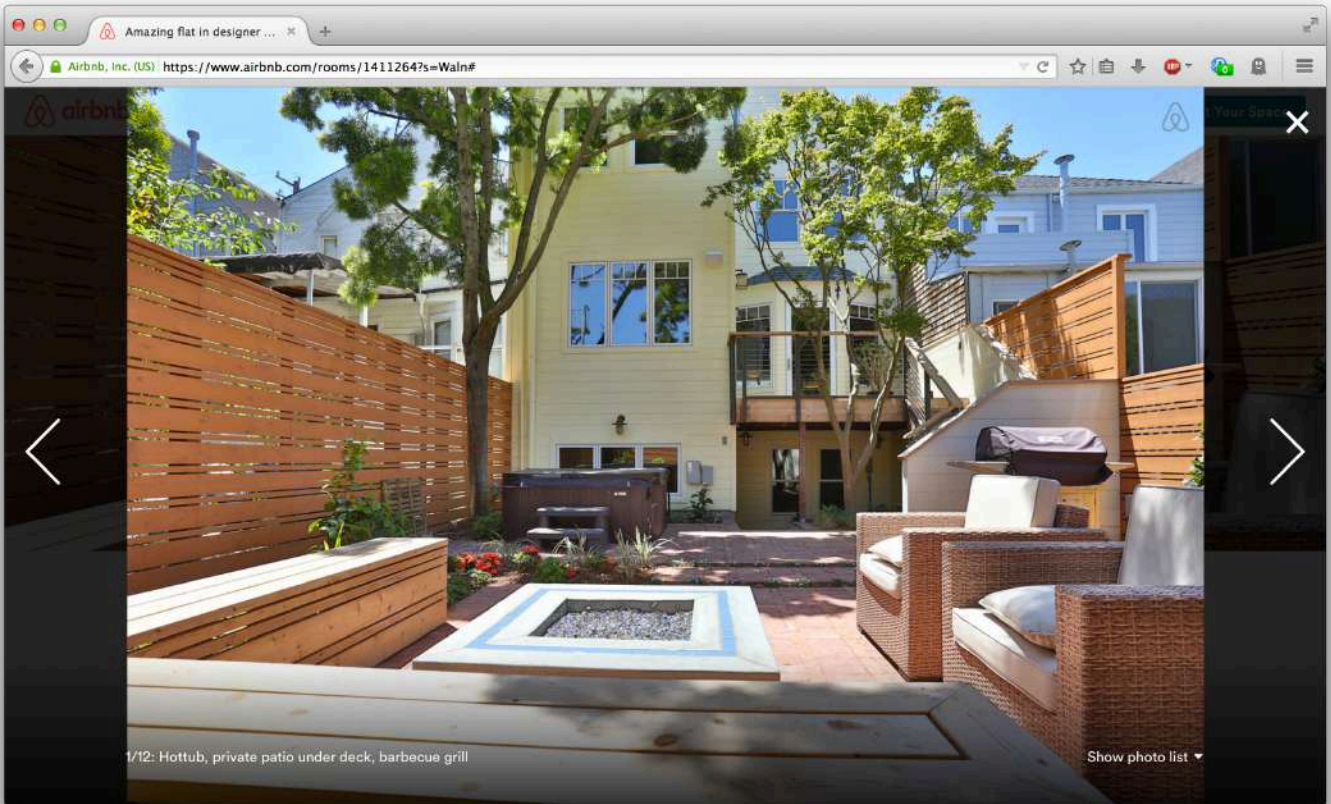



November 28, 2014 at 1:50:18 PM





Exhibit A



September 27, 2011 at 7:43:05 AM

Exhibit B



June 28, 2012 at 7:11:10 PM

Exhibit C

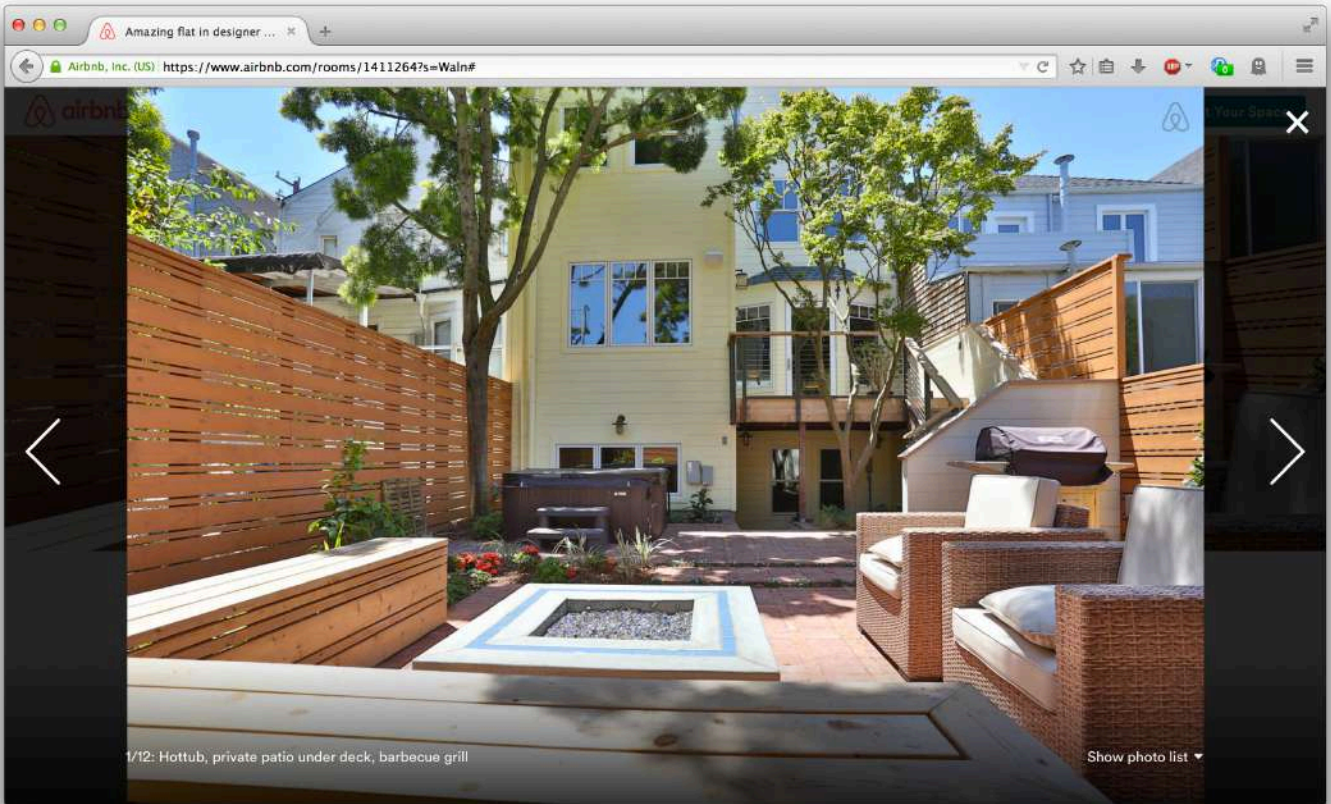
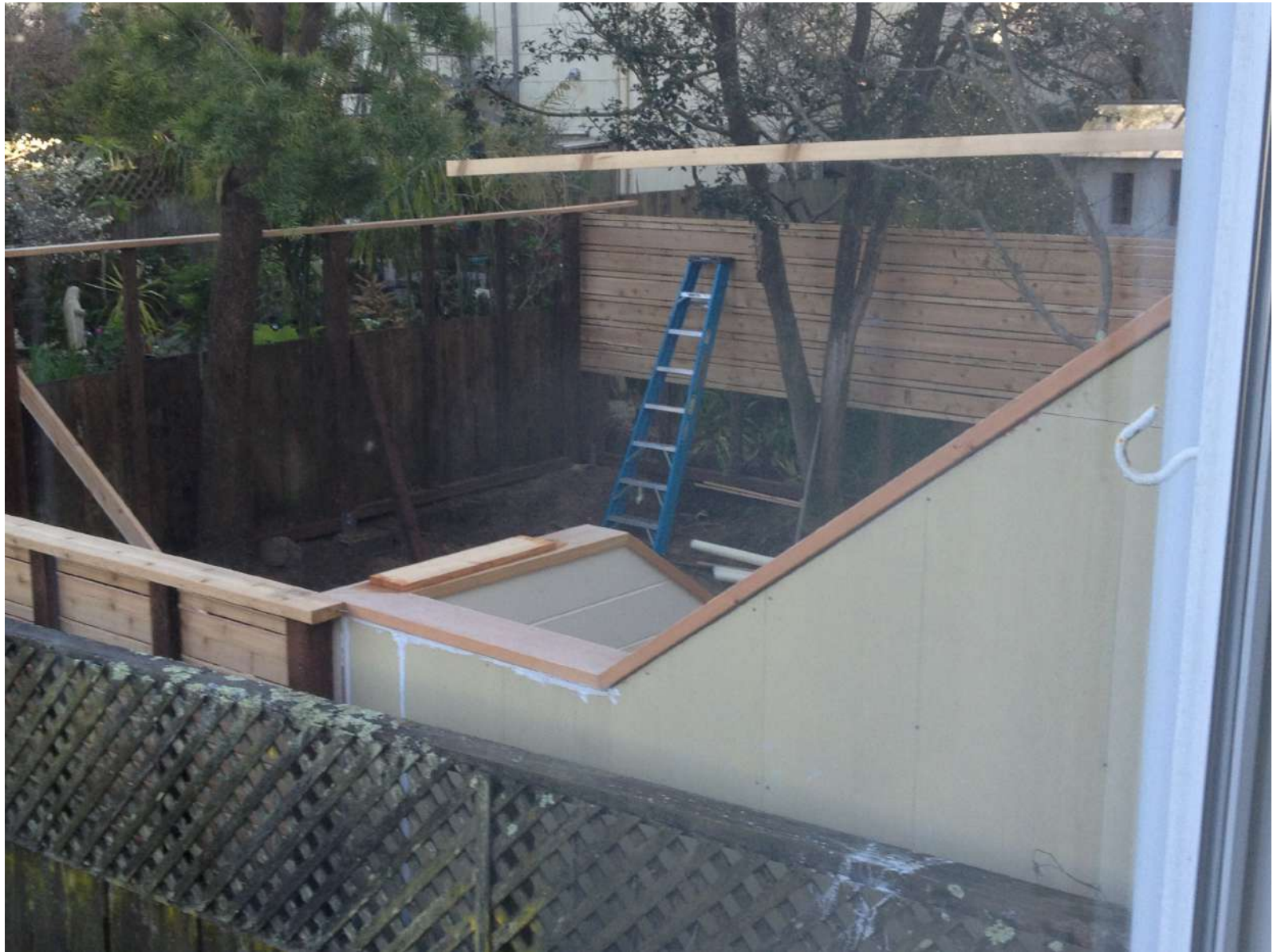

Exhibit D



November 28, 2014 at 1:50:18 PM

Exhibit E



February 20, 2013 at 4:24:11 PM

Exhibit F



March 18, 2013 at 10:17:49 AM

Exhibit G



Description

Amenities

We have a great Queen bed "granny" flat built just for casual use by our friends and family. We just finished a "to the studs" renovation of a designer home in the heart of the Inner Richmond. Enjoy radiant heated floors, great backyard, hot tub, fire pit, kitchen, keyless entry.

The Space

This flat was built just for this. It's pimped out just to handle two guests and a little one if you want them in a pack-n-play. A detached bedroom, detached shower/toilet, an efficiency kitchen will make a for a perfect stay.

Guest Access

Our home was just gutted and renovated with designer/architect specializing in Victorian/Craftsman revival. You'll have access to an amazing backyard oasis with a fire pit, water fountain, pro grill and yes... a new hot tub. The flat has its own private outdoor patio and private entrance via keyless entry from the street. Join us and take the Segways to the Golden Gate Park or a hike in the Presidio, run to the Bridge or walk the Little Russia on Geary or Clement's Lil Chinatown. Easy access to MUNI,

Room type:	Entire home/apt
Bed type:	Real Bed
Accommodates:	2
Bedrooms:	1
Bathrooms:	1
Beds:	1
Extra people:	No Charge
Minimum Stay:	2 nights

♥ **Save to Wish List**

Saved 74 times



Adina

[More about the host](#)

Response Rate **83%**
 Response Time **within an hour**
 Calendar Updated **4 days ago**

Contact Me

How does Airbnb promote safety?

Exhibit H

Amazing flat in designer ...

Airbnb, Inc. (US) https://www.airbnb.com/rooms/1411264?s=Waln#

Photos About this listing Reviews The Host Location

\$235 Per Night

Prices: Extra people: **No Charge** Monthly Price: **\$4606 /month**
Cleaning Fee: **\$60** Cancellation: **Strict**
Weekly Price: **\$1316 /week**

Description

The Space

This flat was built just for this. It's pimped out just to handle two guests and a little one if you want them in a pack-n-play. A detached bedroom, detached shower/toilet, an efficiency kitchen will make a for a perfect stay.

Guest Access

Our home was just gutted and renovated with designer/architect specializing in Victorian/Craftsman revival. You'll have access to an amazing backyard oasis with a fire pit, water fountain, pro grill and yes... a new hot tub. The flat has its own private outdoor patio and private entrance via keyless entry from the street. Join us and take the Segways to the Golden Gate Park or a hike in the Presidio, run to the Bridge or walk the Little Russia on Geary or Clement's Lil Chinatown. Easy access to MUNI, SFO and Marin County.

Interaction with Guests

We're open to greet you and meet or give you the privacy you want for a weekend away. Have Mom and Dad stay here and come and enjoy the backyard with them. This is our fulltime home so we're here but can give you all the space you need.

Availability Minimum Stay: **2 nights** [View Calendar](#)

Check In: mm/dd/yyyy Check Out: mm/dd/yyyy Guests: 1

[Request to Book](#)

[Save to Wish List](#)

Amazing flat in designer ...

Airbnb, Inc. (US) https://www.airbnb.com/rooms/1411264?s=Waln#

Photos About this listing Reviews The Host Location

\$235 Per Night

The Space
 Bed type: **Real Bed**
 Property type: **Apartment**
 Accommodates: 2

Bedrooms: 1
 Bathrooms: 1
 Beds: 1

Amenities

- Kitchen**
- Internet**
- TV**
- Heating**
- Air-Conditioning
- Washer**
- Dryer**
- Free Parking on Premises
- Wireless Internet**
- Cable TV
- Breakfast
- Pets Allowed
- Family/Kid-Friendly
- Suitable for Events

- Smoking Allowed
- Wheelchair Accessible
- Elevator in Building
- Indoor Fireplaces
- Buzzer/Wireless Intercom
- Doorman
- Pool
- Hot Tub**
- Gym
- Smoke Detector**
- Carbon Monoxide Detector
- First Aid Kit
- Safety Card
- Fire Extinguisher

Check In: mm/dd/yyyy Check Out: mm/dd/yyyy Guests: 1

Request to Book

Save to Wish List

Prices

Extra people: **No Charge**
 Cleaning Fee: **\$60**
 Weekly Price: **\$1316 /week**

Monthly Price: **\$4606 /month**
 Cancellation: **Strict**

Exhibit I

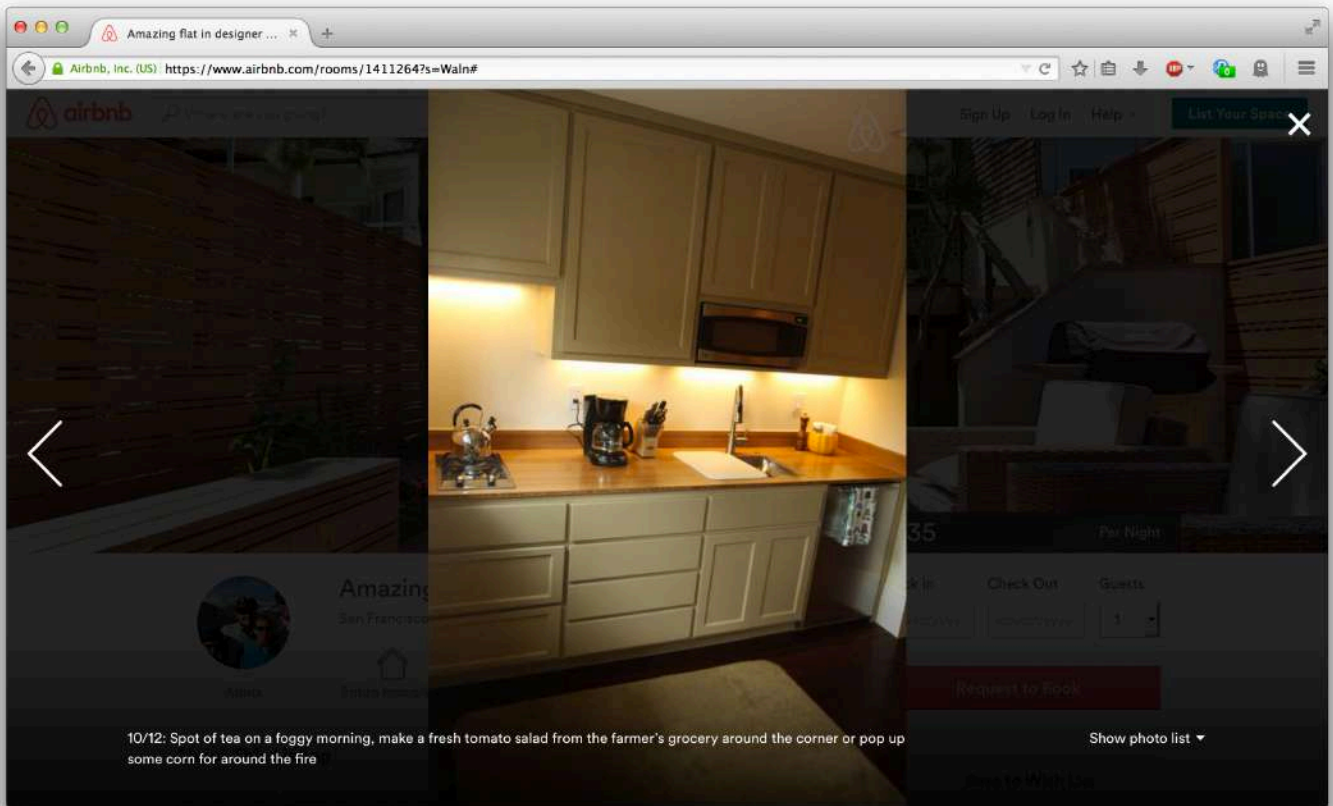

Exhibit J

KEMBCON ENGINEERS
STRUCTURAL AND CIVIL ENGINEERS
P.O. BOX 389
MILLBRAE, CA 94030
650-343-8310 (voice)
650-343-8312 (fax)
engineers@kembcon.com

5 February 2015

To Whom It May Concern:

I am the engineer of record for the repair of the foundation at 478 16th Avenue, in San Francisco, CA. On 22 January 2015, I met with the owners of 478 16th Avenue at the San Francisco Department of Building Inspection.

Together we reviewed the building permit files for the three buildings at 478, 482 and 486 16th Avenue.

We learned that all three building were constructed under permits issued on August 26, 1911. This was after the 1906 earthquake, when the City was expanding out onto the sand dunes to the west of the existing developed area.

Since the damage to the building at 478 16th was caused by the undermining of its foundation during the excavation at 482 16th, we looked at the permit file to determine what construction was authorized by permit.

We found that a building permit was issued for exploratory demolition in 2012. This was to allow the owners to determine the depth and extent of the existing foundations at the area where the ceiling height was to be increased.

We found that a second permit was issued on April 19, 2013 for changing the rear roof to a roof deck. This plan shows the existing straight run stair to the backyard to remain.

We found that a third permit was issued on May 11, 2012. for the work at the lower floor of 482 16 th Avenue. Plans were prepared by DD Engineering. Plans showed that the work would not affect the foundation at the side adjacent to 478 16th. Details 3 and 4 on sheet S2 showed that they proposed to leave the existing trapezoidal foundation and dowel the new slab into it.

At the property line between 482 16th and 486 16th, the foundation was to be undermined only at the extreme rear, where the new habitable space was to be created.

On Sheet S2, there is a note by the details for the foundation work that reads:

"Where undermining occurs:

- 1. Verify cohesive soils below neighbor's footing. Pour new foundation in 8'-0" maximum sections.**
- 2. Provide shoring and/or epoxy soil injection under separate permit where cohesionless soils occur.**
- 3. Owner of adjacent property shall be notified 30 days prior to commencement of excavations. "**

On May 21, 2012, a fourth permit was issued based on plans by Artistic Designs were submitted showing interior remodel work. These plans showed:

- Existing straight stair to rear yard to remain.**
- No new slab at east side of garage**
- Deck at rear is existing**
- New bathroom , playroom and workout room to be constructed in the garage area.**
- A wet bar was proposed but denied by the Planning Department.**

On July 25, 2012, a fifth permit was issued based on plans by DD Engineering. These plans show that the footing between 482 16th Avenue and 478 16th Avenue was to be undermined "2'-5" maximum". The existing trapezoidal footing of 482 16th was to be demolished in three separate operations and replaced with a new "elf" shaped foundation wall. The same notes were shown on the plan:

"Where undermining occurs:

- 1. Verify cohesive soils below neighbor's footing. Pour new foundation in 8'-0" maximum sections.**
- 2. Provide shoring and/or epoxy soil injection under separate permit where cohesionless soils occur.**
- 3. Owner of adjacent property shall be notified 30 days prior to commencement of excavations. "**

The plans show that the old foundation is to be demolished and the new foundation to be constructed in three separate sections.

The plans show the existing straight stair to the rear yard to remain.

The plans show the existing trapezoidal foundation at 478 16th Avenue to remain.

Based on my review of the approved permit plans and upon examination of the photographs which my clients showed me and upon my visual inspection of the present conditions and the documents which my clients found on the web and printed out, I conclude the following:

The owners of 482 16th Avenue or their contractors:

- **Constructed an illegal second unit in the lower level of their dwelling and are offering it for rent on the internet**
- **Demolished the existing straight stairway to their rear yard and constructed a new dog leg stairway inside the side yard setback without obtaining a permit for this work.**
- **Changed the door and window at the lower floor of the illegal unit without a permit**
- **Undermined the foundation of 478 16th Avenue without either underpinning, grouting or shoring the existing foundation.**
- **Demolished and removed almost all the foundation at the North side of at 478 16th Avenue without obtaining a demolition permit**
- **Shored the lower floor of 478 16th Avenue without a building permit**

The undermining of the foundation occurred because the soil in the area, as in much of the Richmond, is free running dune sand. This is about as distant from "cohesive" soil as it could possibly be.

It is my professional opinion, as a retired general contractor, as a registered civil and structural engineer and a long time member of first the ICBO and later the ICC, that the owners of 482 16th Avenue did work without a permit, exceeded the scope of the permits that they did have and deliberately violated the San Francisco Planning Ordinance.

Sincerely,

**Eric Cox, RSE
President**



FEB 05 2015

Exhibit K



June 4, 2009 at 4:33:09 PM

Exhibit L



Exhibit M



Exhibit N

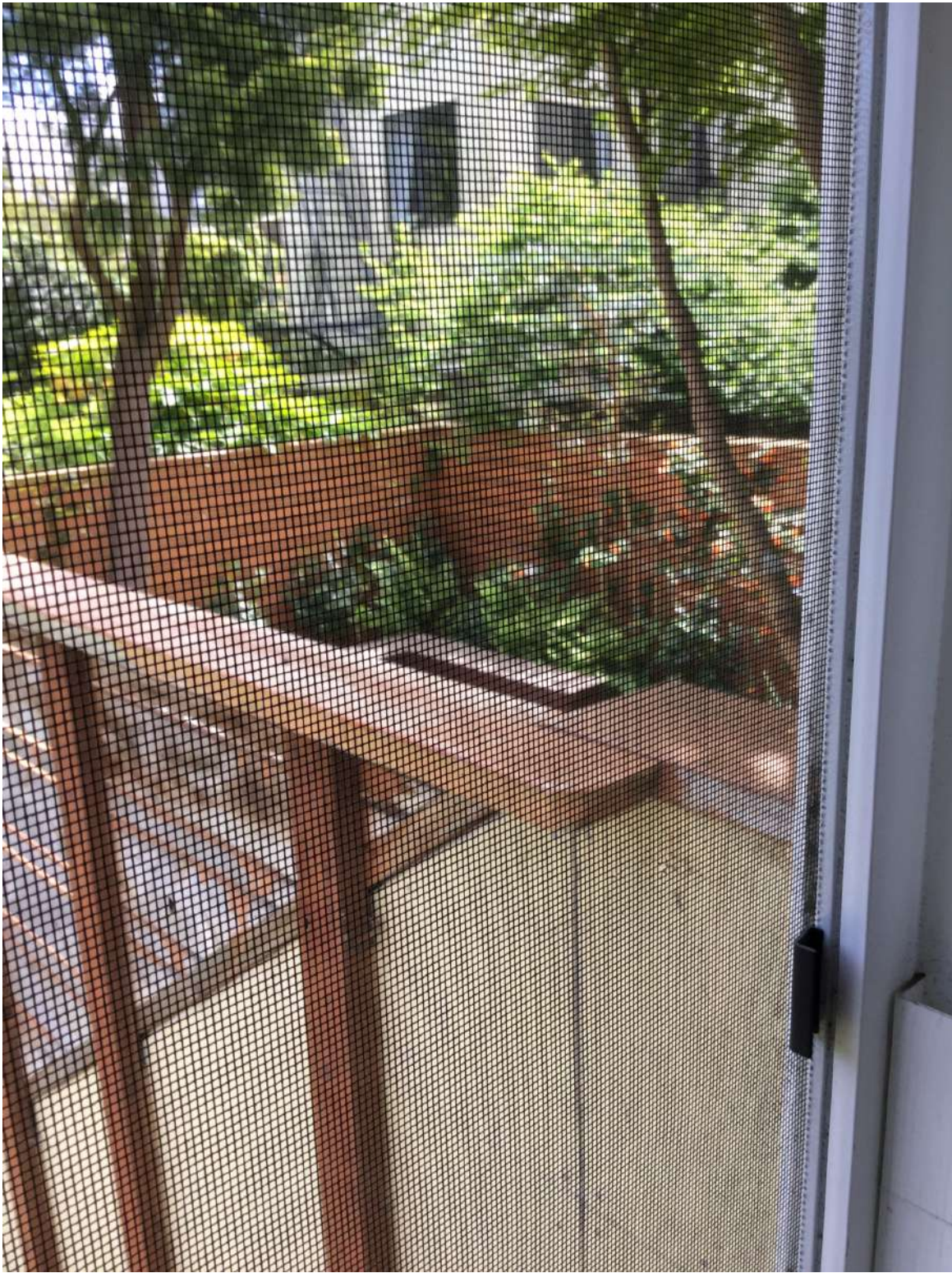

March 30, 2016 at 12:19:21 PM



March 2, 2015 at 1:22:55 PM

Exhibit O

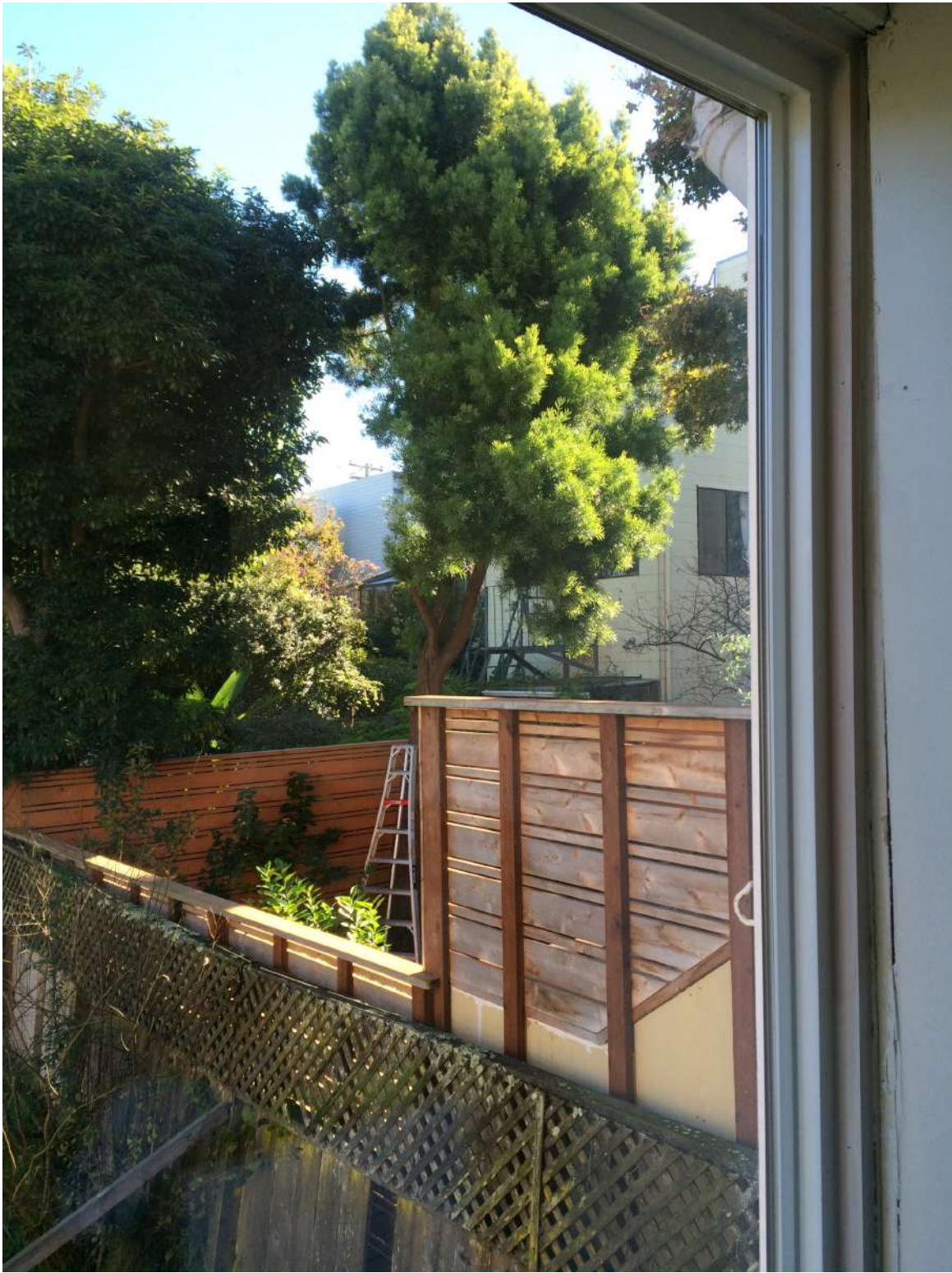

November 24, 2014 at 11:12:56 AM

Exhibit P





THE OTHER PARTIES DID NOT SUBMIT ANY
BRIEFS FOR THIS APPEAL